

Elżbieta Jasińska\*, Edward Preweda\*

A FEW COMMENTS ON DETERMINING THE SHAPES OF HYPERBOLOID  
COOLING TOWERS BY THE MEANS OF AMBIENT TANGENTS METHOD

---

## 1. Introduction

Almost 80 cooling towers operating in Poland are subject to periodical measurements on the current basis. Due to the technical condition of the cooling towers, operating for more than 20 years, the problematics of determining the shape of shell structures is still timely, in spite of the fact that the methods of measurements and determining the shape of shell structures are commonly known. A significant number of measurements are continued to be performed by the means of the ambient tangents method [2, 3]. Although this method is being phased out from the market and replaced with the spatial incision method, polar line method, observations with use of the GPS receivers and photogrammetry methods, the economic reasons cause the observations by the means of the ambient tangents method to be still applied by a significant number of contractors. This induces the Authors to present the possibilities of improving this method and to show that the modification of calculations allows improving the accuracy of the results obtained. The detailed algorithm describing the new method of determining the so-called "tangent length"<sup>1)</sup> awaits printing in [5]. This paper presents the results of calculations of the model structure in order to illustrate the differences between the classical and modified approach.

## 2. The length of the tangent to a hyperboloid

The coordinates of the points observed in the ambient tangents method may be determined from the following relation:

$$x = X + e \chi d,$$

---

\* AGH University of Science and Technology, Faculty of Mining Surveying and Environmental Engineering

<sup>1)</sup> "tangent length -in the ambient tangents method it is understood to be the horizontal distance between the station and the point of tangency with the structure

$$y = X + e_y d,$$

$$z = X + e_z d,$$

where:

$(X, Y, Z)$  - coordinates of the station,

$(x, y, z)$  - coordinates of the tangency points,

$d$  - distance between the station and the point of target tangency to the structure,

$[e_x, e_y, e_z]$  - vector parallel to the tangent, expressed by means of observations.

The basic computation problem found in the ambient tangents method is the way of determining the so-called length of the tangent. The literature to date has adopted that the tangent in the horizontal layout is perpendicular to the radius of the specific observation cross section. Among the others, this adoption causes that the method in question provides with less accurate results as compared to the polar line method or spatial incision method. Depending on the structure, the dimensions thereof, as well as the location of the station towards the structure, the actual length of the tangent is longer or shorter than the distance as determined by the means of the rule presented above, while the coordinates of tangency points determined represent only a certain approximated model of the shell.

The detailed contemplations as to the determination of the length of the tangent to the one-shell hyperboloid, based upon the canonical equation of the surface

$$f(x, y, z) = \frac{x^2}{a^2} + \frac{y^2}{b^2} - \frac{(z - z_0)^2}{c^2} - 1 = 0$$

as well as the length of the tangents to any arbitrary surface of the second-degree have been presented in [5].

The differences between the classical approach to the problem (tangent  $t$ ) and the modified algorithm (tangents  $t_1, t_2$ ) have been shown on the Figure 1.

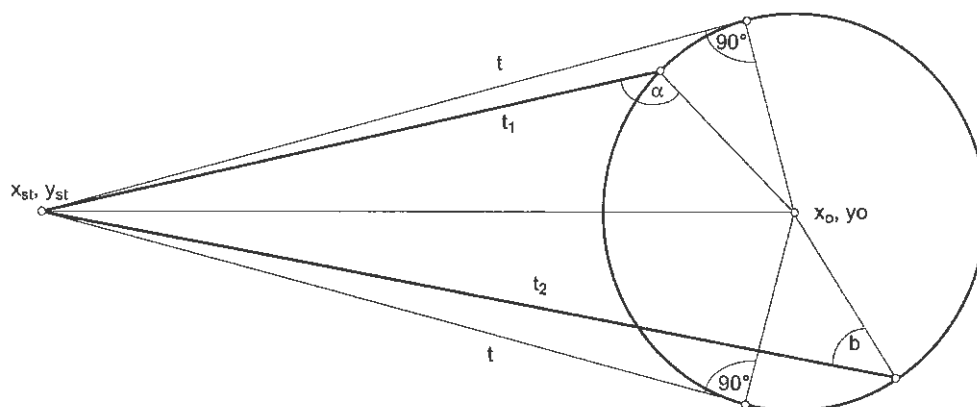


Fig. 1. Location of the points of target tangency depending on the location of the observation station towards the structure

### 3. The differences as to the length of the tangents depending on the adopted method of calculations

The model of the cooling tower, upon which the analyses hereunder provided are based, has been generated by means of the computer. The heights of the observation stations and the distances from the centre of the cooling tower have been designed so that the relation between the two methods of determining the length of the tangent depending on the location of the measuring station towards the structure under examination can be shown. It is worth noticing that the theoretical location of tangency points depends on the method of determining the length of the tangent not only in terms of the distance from the station but also in terms of the height of the point of tangency being determined (Figs 2-11).

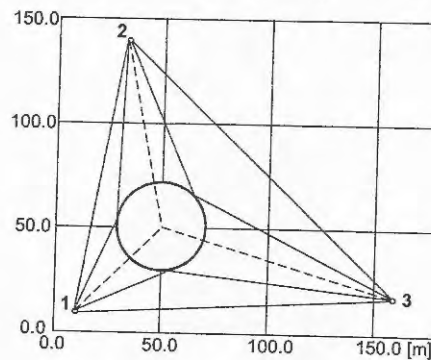


Fig. 2. Draft of the minor control

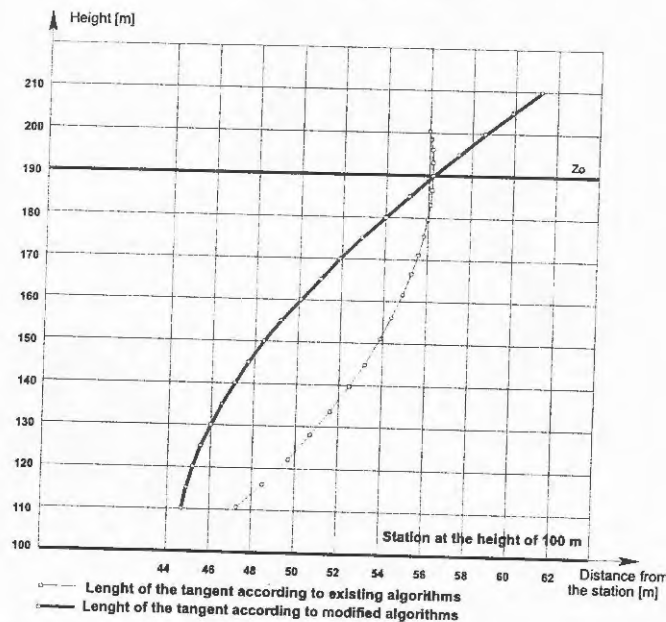


Fig. 3. Horizontal lengths of the tangents - distance from the station to the centre of the cooling tower = 60 m

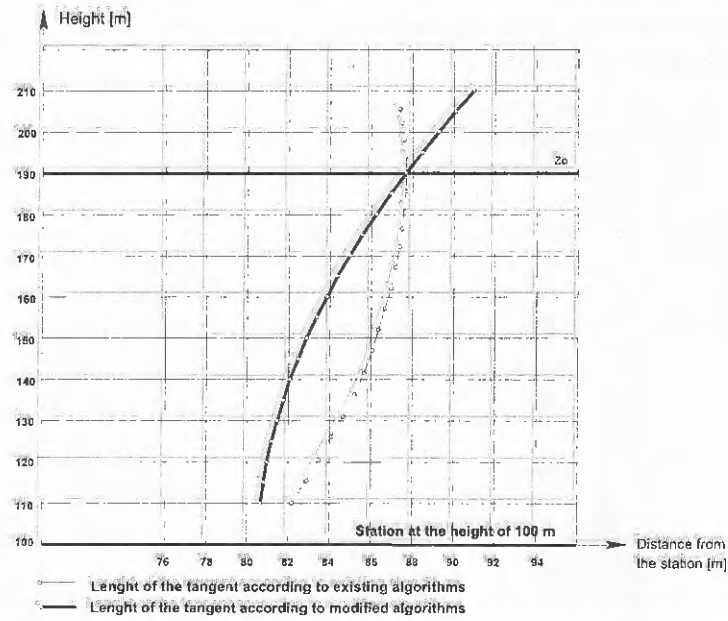


Fig. 4. Horizontal lengths of the tangents - distance from the station to the centre of the cooling tower = 90 m

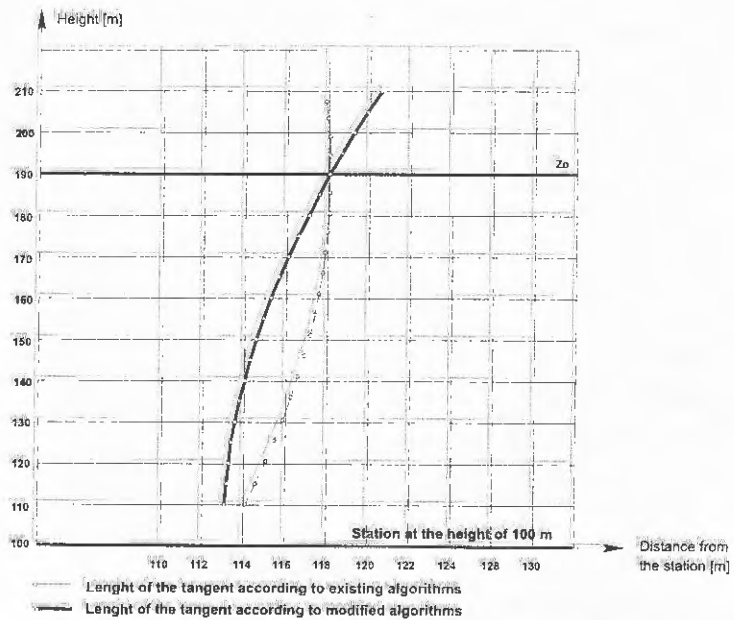


Fig. 5. Horizontal lengths of the tangents - distance from the station to the centre of the cooling tower = 120 m

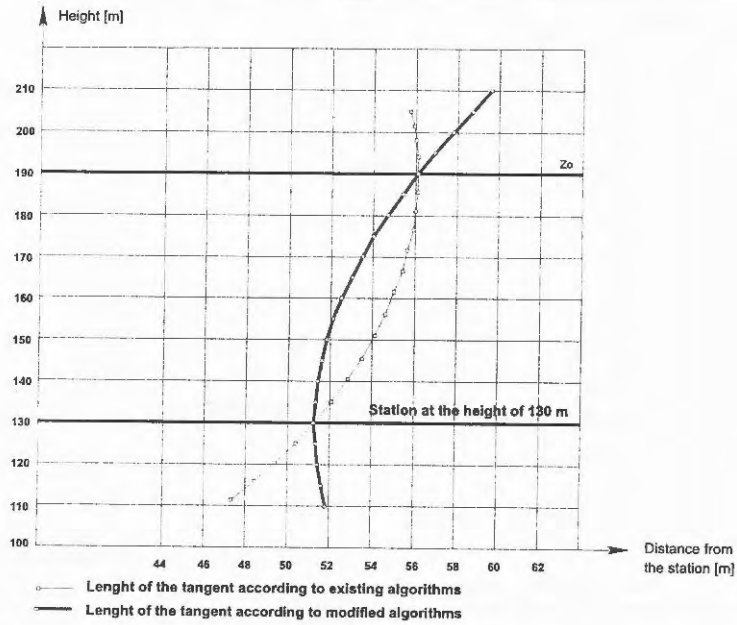


Fig. 6. Horizontal lengths of the tangents - distance from the station to the centre of the cooling tower = 60 m

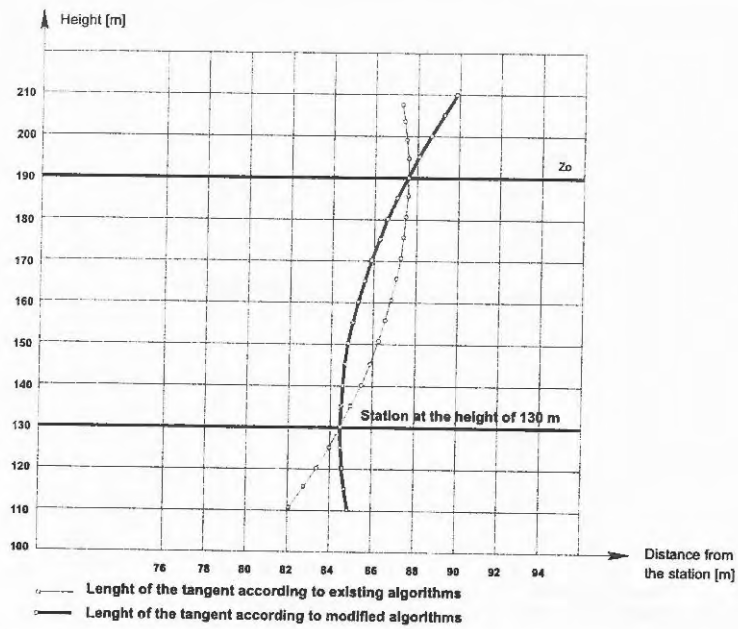


Fig. 7. Horizontal lengths of the tangents - distance from the station to the centre of the cooling tower = 90 m

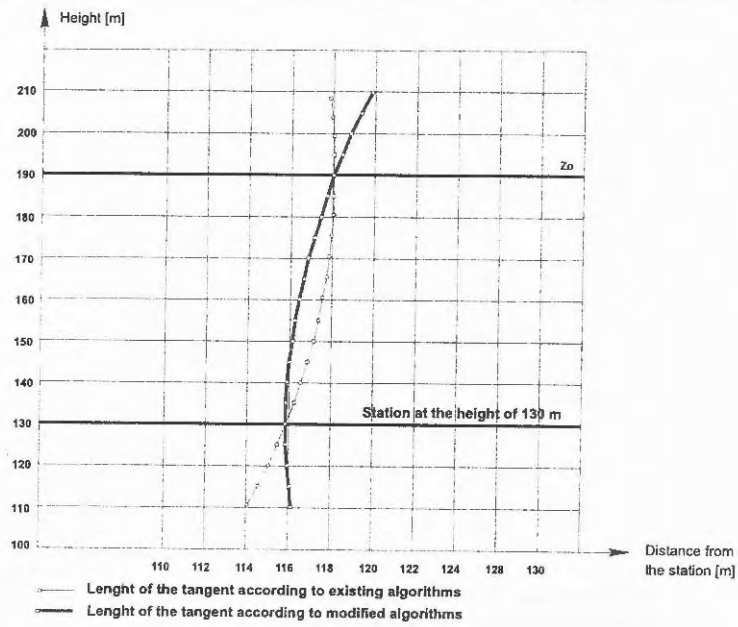


Fig. 8. Horizontal lengths of the tangents - distance from the station to the centre of the cooling tower = 120 m

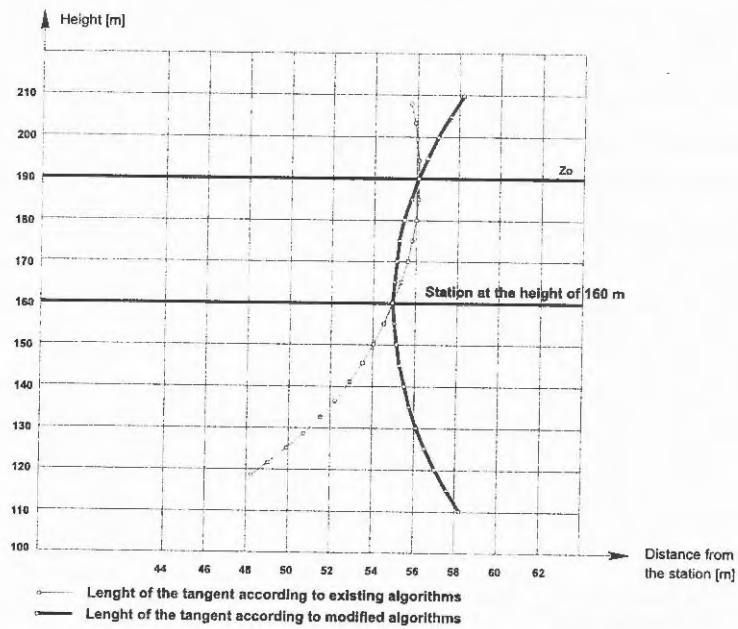


Fig. 9. Horizontal lengths of the tangents - distance from the station to the centre of the cooling tower = 60 m

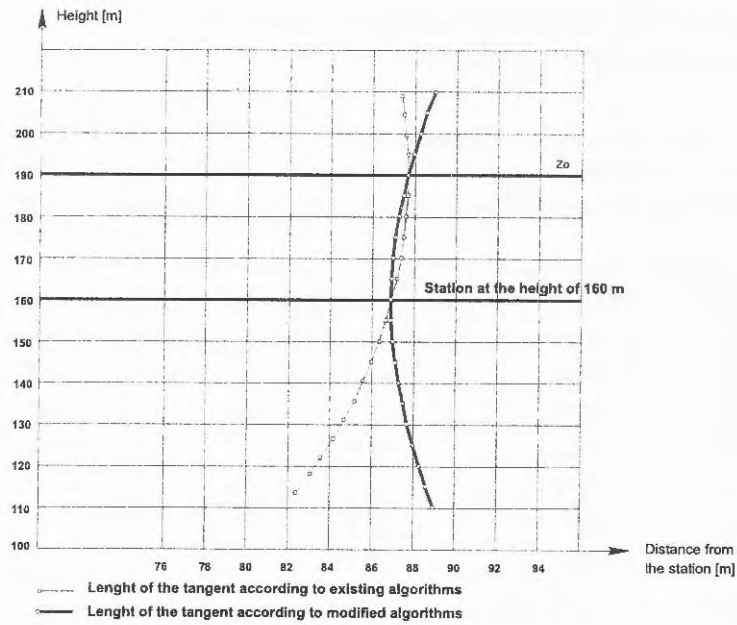


Fig. 10. Horizontal lengths of the tangents - distance from the station to the centre of the cooling tower = 90 m

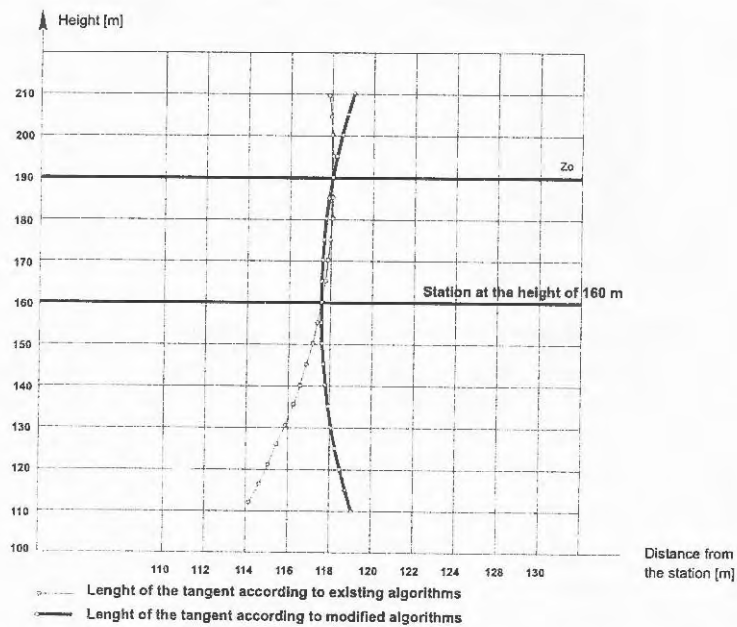


Fig. 11. Horizontal lengths of the tangents - distance from the station to the centre of the cooling tower = 120 m

#### 4. Impact of the length of the tangent on the parameters of the surface being approximated

Further sections of this paper (Tabs 1–4, Figs 12, 13) show how the length of the tangent determines the principal parameters of the surface being approximated and the patience of the shape of the shell under examination with relation to the mathematical model.

Table 1. Parameters of the model shell – station at the height of 100 m

	Adopted model	Parameters in accordance with the algorithm applied to date	Parameters in accordance with the modified algorithm
$X_0$ [m]	50,000	50,000	50,000
$Y_0$ [m]	50,000	50,000	50,000
$Z_0$ [m]	190,000	189,847	190,000
$a = b$ [m]	21,000	21,000	21,000
$c$ [m]	55,000	55,036	55,000
Deflection [g]	0,0000	0,0320	0,0000
Deflection azimuth [g]	–	102,6765	–

Table 2. Parameters of the model shell – station at the height of 130 m

	Adopted model	Parameters in accordance with the algorithm applied to date	Parameters in accordance with the modified algorithm
$X_0$ [m]	50,000	50,000	50,000
$Y_0$ [m]	50,000	50,000	50,000
$Z_0$ [m]	190,000	190,049	190,000
$a = b$ [m]	21,000	21,000	21,000
$c$ [m]	55,000	55,045	55,000
Deflection [g]	0,0000	0,0001	0,0000
Deflection azimuth [g]	–	179,3903	–

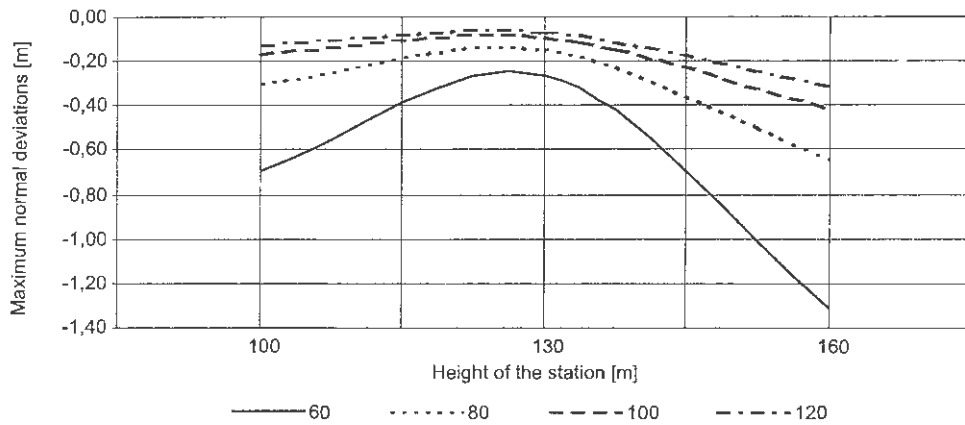
Table 3. Parameters of the model shell – station at the height of 160 m

	Adopted model	Parameters in accordance with the algorithm applied to date	Parameters in accordance with the modified algorithm
$X_0$ [m]	50,000	50,000	50,000
$Y_0$ [m]	50,000	50,000	50,000
$Z_0$ [m]	190,000	190,216	190,000
$a = b$ [m]	21,000	21,000	21,000
$c$ [m]	55,000	55,394	55,000
Deflection [g]	0,0000	0,0000	0,0000
Deflection azimuth [g]	–	–	–

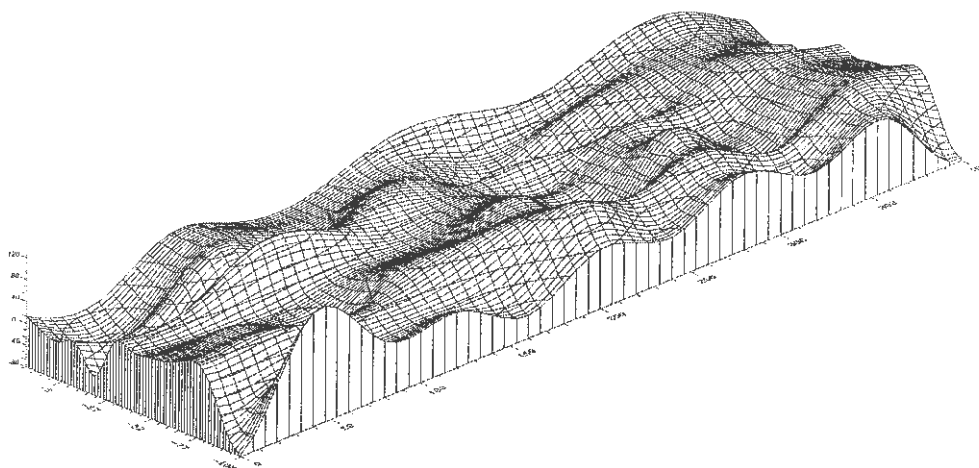


**Table 4.** Maximum normal deviations [m] of the shell under examination with relation to the model shell, depending on the heights and distance of the station from the structure centre, determining by the means of the algorithm applied to date

Distance from the centre	Height of the station		
	100 m	130 m	160 m
60 m	-0,698	-0262	-1,307
80 m	-0,296	-0141	-0,641
100 m	-0,163	-0,087	-0,406
120 m	-0,116	-0,061	-0,304



**Fig. 12.** Illustration of the distribution of the maximum normal deviations depending on the height and distance of the station from the centre of the structure



**Fig. 13.** An example of deformation of the real shell arising out exclusively from the non-rigorous method of calculating the length of the tangent

### **5. Other factors influencing the length of the tangent being determined**

The thin-wall structures, which include hyperboloid cooling towers, must meet the condition of conformity of their surface median to the surface as determined by design assumptions. The thickness of the shells of the cooling towers constructed depends on the tensions and stresses anticipated at the designing stage and most frequently is not constant for the entire shell. Normally, a few zones with thickness diversified in a continuous way, can be found [1, 9]. In order to transmit the stresses, the shell in the bottom part of the cooling tower and around the outlet is subject to the application of larger thickness. Due to the various thickness of the shell, the lengths of the tangents determined are only approximate lengths. Therefore, the introduction of the two-stage method, allowing to reduce the directions tangent to the surface median of the structure, is necessary. The algorithms constituting the solution to this problem have been presented in [10].

If, in the course of determining the length of the tangent to the shell, it is possible to include the thickness of the shell, it is not possible to include the local deformations of the shell and its inclinations from the vertical line. The impact of these factors is very difficult for a general description, as it depends on the degree of the deformation of the structure. The testing performed at some actual structures shows that the length of the tangent may suffer from the inaccuracy in the order even of a few centimetres. This inaccuracy causes that the deviations of the shape of the shell being examined compared with the model one, suffer from the inaccuracy in the order of same 1cm.

### **6. Conclusions**

Testing the complex configurations, phenomena and processes, which undoubtedly includes the determination of the shape of hyperboloid cooling towers based upon the observations of the discrete set of points, requires the application of models constituting the simplified mapping of the reality. As a result, the models being developed include only the most essential factors, determining the changeability of the phenomenon under examination, disregarding at the same time a number of side factors. The determination of the geometry and the shape of the hyperboloid cooling towers is even more complicated as the main factor, which we intend to take picture of, i.e. the deformation of the structure in time, is influenced by a number of side factors, as well as random factors, such as the impact of temperature, wind pressure, insolation, arrangements of observation points, method and accuracy of measurements. It is highly likely that a number of unpredicted factors also occur, which influence the results of our developments in an uncontrollable way. One of the objectives of the modelling is to solve engineering problems with the use of the most recent information and measuring technology, at the same time the costs and realization time of the project being minimized. The method of ambient tangents is a cheap and rapid one, therefore it is continued to be used in the geodesy routine in spite of a number of more accurate methods of observations. The introduction of the improvements into the computational

algorithms improves the accuracy of the results obtained. Taking into consideration the economic aspects, in the case of routine surveyors, where the safety of the structure is not subject to any hazards, the accuracy of the modified method of the ambient tangents may be found sufficient.

### Bibliography

- Centkowski J.: The selection of the hyperboloid cooling tower [in Polish]. Engineering and Construction Industry, No 6, Warsaw, 1993
- Czaja J.: Generalized method of determining the location and shape of the rotational building structures with surface of second-degree [in Polish]. Geodesy and Cartography, No 3, Polish Scientific Publishers, Warsaw, 1984
- Gocał J.: Principles of performing geodesy testing of hyperboloid cooling towers [in Polish]. Scientific Books of AGH University of Science and Technology, Geodesy, z 61, Cracow, 1980
- Preweda E.: Estymacja parametrów kinematycznego modelu przemieszczeń. Rozprawy Monograficzne, 110, AGH, Kraków, 2002: 1-102
- Jasińska, E., Łacina, W., Preweda, E., Żygiel, P.: A modified algorithm of determining the shape of shell objects using the method of conical intersection. Electronic Journal of Polish Agricultural Universities, Series Geodesy and Cartography, 2003
- Latos S., Preweda E.: Position and shape parameters of second order surface estimated by points and intervals. Perelmuter Workshop on Dynamic Deformation Models, Haifa, 1994: 117-126
- Majde A.: Conversatorium "Cooling towers measuring methods" [in Polish]. Course, problems and conclusions, Geodesy Review, No 10, Warsaw, 1991
- Preweda E.: Ocena stanu geometrycznego obiektów powłokowych względem dowolnych powierzchni drugiego stopnia. ZN, Geodezja, 115, AGH, Kraków, 1993: 83-96
- Preweda E.: System pomiaru, obliczeń i wizualizacji zmian geometrycznych obiektów powłokowych o powierzchni stopnia drugiego. Praca doktorska, AGH, Kraków, 1994
- Preweda E.: Aproksymacja środkowej powierzchni powłok. Geodezja, 3, AGH, Kraków, 1997: 149-160