

The Evolution of the Ophthalmic Surgical Microscope

ILLUSTRATIONS

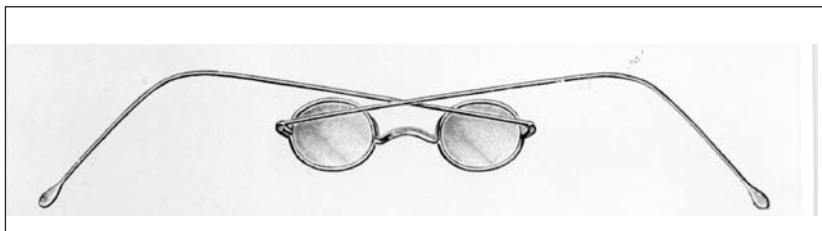

Fig. 1: Bishop Harman binocular loupe

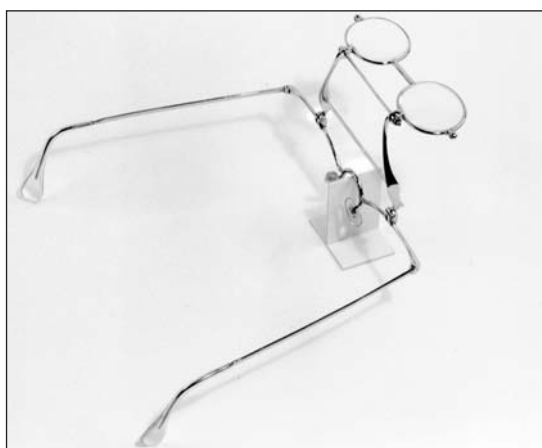

Fig. 2: Bi-convex lenses on extended arm

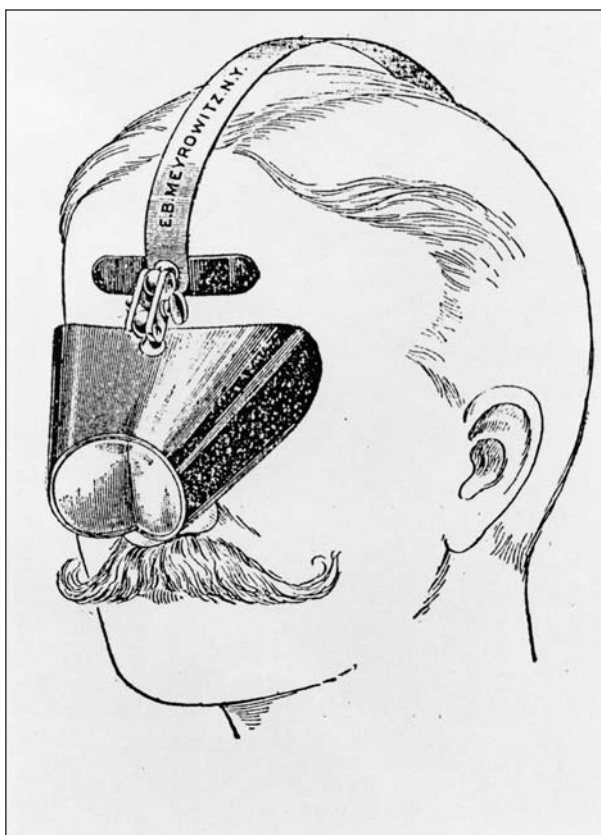

Fig.3: Berger loupe

The Evolution of the Ophthalmic Surgical Microscope

Short title: *Ophthalmic Surgical Microscope*

Richard Keeler

Abstract

The use of magnification in eye surgery goes back to the 19th century and consisted of a spectacle frame with single plus lenses worn towards the end of the nose. The ophthalmic operating microscope was first introduced in the 1950s but was slow to take off. This paper will explain the reluctance to adopt this new tool and the early developments that have led to today's sophisticated microscope

The microscope has for long been an indispensable tool in ophthalmic surgery. The first reported use of a binocular surgical microscope in ophthalmology was nearly 100 years after Richard Liebreich described his method of using magnification in ophthalmic examinations in 1855.

If this was a long interval, perhaps even more strange was the lapse of 25 years between the first use of a floor-stand-mounted binocular microscope used in otology and a table-mounted microscope used for ocular procedures in 1946. To add to the mystery, during this same period, the binocular slit-lamp microscope had become an essential instrument for examining the cornea and anterior chamber. It would have seemed very logical to have mounted the slit-lamp microscope in a similar way to the proven system of suspension used by the otologists but this did not happen.

This article will trace the evolution of magnification systems used by ophthalmic surgeons until the late 1960s, and will attempt to throw some light on why it took so long for the stand-mounted binocular microscope to be used in ocular surgery.

HEAD WORN MAGNIFICATION

Before the advent of the binocular surgical microscope in the 1950s, ophthalmic surgeons had been using a variety of specta-

cle or headband, mounted magnifying systems, as had reported Edward Landolt in a review of surgical loupes in 1920.¹ These methods can be grouped into three categories: single-lens magnifiers, prismatic magnifiers and telescopic systems.

SINGLE-LENS MAGNIFIERS

Single-lens magnifying loupes in their simplest form were spectacles with convex lenses suspended at the end of the nose, such as the Bishop Harman binocular loupe (Fig.1), or convex lenses with added base-in prism attached to a spectacle frame on extended arms (Fig.2). One of the most popular forms of magnification over many years was the Berger loupe (Fig.3) which used sphero prisms in an enclosed hood attached to the head with a strap. There were a number of variations of this design of loupe. For instance, illumination was added in one option, and in another the instrument was constructed in a skeleton form (Fig.4, see p.36). In 1908 Edward Treacher Collins used the same sphero prisms (Fig.5, see p.36) and attached them to a spectacle frame to which the operator's prescription could be added. This type of loupe in which the single convex lens was used in combination with the surgeon's own prescription was quite common. A popular loupe was the Beebe (Fig.6, see p.36, first produced in 1914. This used lenses of +7.50 dioptres with 5° base in prism adjustable to a range of interpupillary distances and providing a magnification of 2.3x. The surgeon could use his own prescription or trial lenses in conjunction with the magnifying lenses (Fig.7, see p.38). The *Bausch and Lomb Dualoupe* (Fig.8 see p.38) was a form of *Beebe loupe* but the lenses were hinged so that they could be swung out of the way when not required.

Richard Keeler
1 Brookfield Park
London NW5 1ES
UK
rkeeler@blueyonder.co.uk

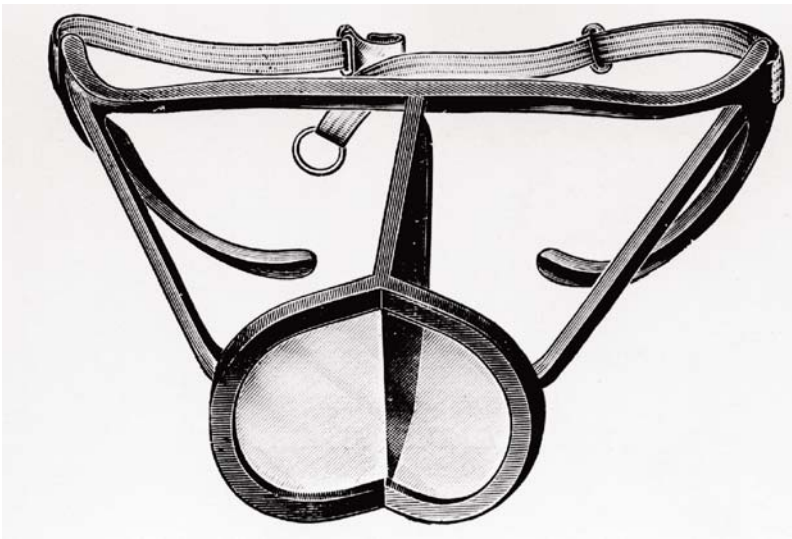

Fig 4: Berger loupe - skeleton form

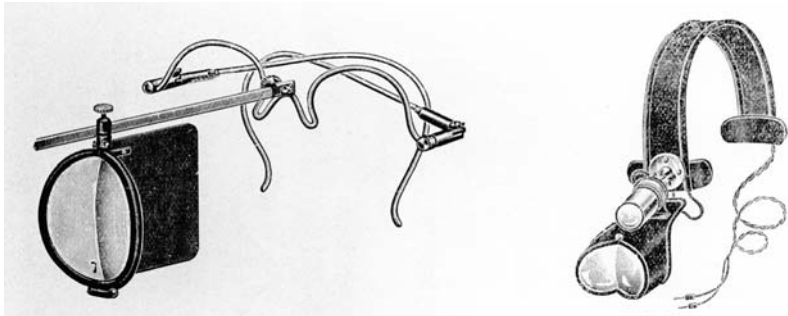
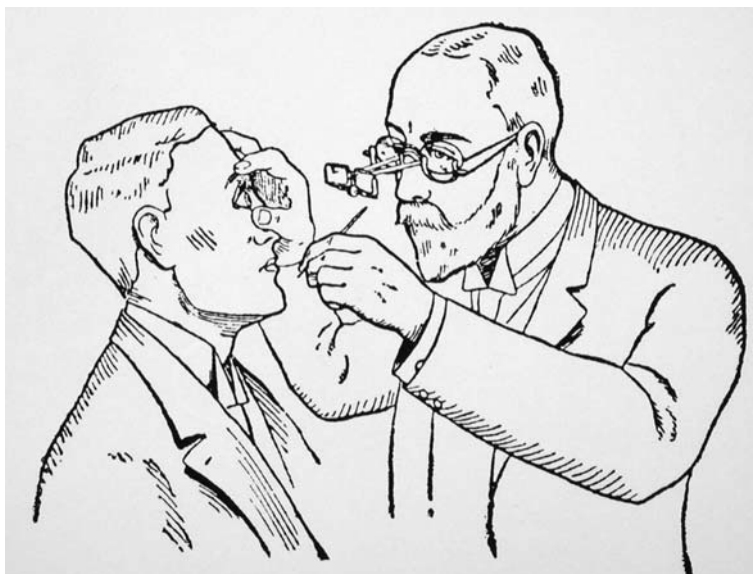

Fig. 5: Treacher Collins loupe



6. Beebe loupe

Stewart Duke-Elder had designed for him two loupes (Fig.9 *see p.38*), both of which used the surgeon's prescription in the host frame with the convex lenses suspended on arms to give a magnification of approximately 1.5x. Angling of the frame front could be increased or decreased by engaging a metal peg in a small vertical extension arm. The clip on version could be attached to most frame styles but could not be swung out of position, unlike his other design (Fig.10 *see p.38*).

PRISMATIC MAGNIFIERS

Binocular magnifiers using prismoculars and lenses were first introduced in 1912 by the Carl Zeiss Company (Fig.11 *see p.39*). Their binocular loupe gave a magnification range of 0.75-3.0x depending on the eye lenses. Initially this loupe was worn on the nose with a strap around the head, but the discomfort due to its weight, especially when illumination was added, attracted alternative methods of wear, such as an over headband, or the facial cage with headstrap as illustrated in Fig.12, (*see p.39*).

TELESCOPIC SYSTEMS

With the limitation of power and working distance in single lens systems, the desire to have more magnification at a longer working distance in a spectacle, or head, mounted form meant that an alternative system was needed. The Galilean telescope provided this. The simplest form was an 'open' Galilean loupe (Fig.13) with small high minus lenses at the back separated from high plus lenses held in front and mounted on a frame, with the surgeon's prescription incorporated. This Galilean combination was hinged so that it could be flipped up out of the visual path when not required.

One of the first closed Galilean systems was designed by Edward Jackson of Philadelphia in 1897.² He mounted converging telescopes on a bar attached to an overhead band (Fig.14 *see p.39*). The telescopes focussed at 15cm and gave 3x magnification. But it was the introduction by Carl Zeiss, Jena, of their 2x miniature telescopes, designed by Dr M von Rohr³ with the advice of Dr W Stock in 1912, that transformed the surgeon's abi-

lity to work comfortably with higher magnification. Allvar Gullstrand was the first to try these spectacle mounted achromatic telescopes, and they rapidly became the standard surgical loupe for ophthalmic surgery. Initially the focal length was 20 cms, but later Zeiss and other manufacturers provided a choice of focal length and magnification. Zeiss had various ways in which the telescopes could be mounted, including adjustable (Fig.15 *see p.39*) and individually fitted frames for normally sighted people (Fig.16 *see p.39*), as well as a method whereby the telescopes could be attached to the surgeon's own correcting glasses mounted in a metal frame (Fig.17 *see p.41*).

The Keeler Galilean telescopic system was introduced in 1952 at the suggestion of Charles S Hallpike, an otologist in London. The telescopes of 2x magnification at 25cms were mounted in angled rings on a fixed bar, individually measured according to the surgeon's interpupillary distance. The mounted telescopes on their bar were screwed on to prongs protruding from the spectacle frame (Fig.18 *see p.41*). With this system Keeler offered a wide choice of magnification from 1.75x to 9x, and working distance from 34cms down to 16.5cms (Fig.19 *see p.41*). Later, the fixed interpupillary bar was replaced by a continuously curved bar enabling the surgeon to adjust the telescopes to his own interpupillary measurement, and, importantly, to correct any difference of the two eyes from the median point (Fig.20 *see p.41*).

HIGHER MAGNIFICATION SYSTEMS 1855 – 1921

The discovery of the ophthalmoscope by Hermann von Helmholtz in 1850 had opened up a new world to the ophthalmologist in his examination of the internal structures of the eye, especially the retina. However, at that time examination of the cornea and anterior chamber under magnification was restricted to a simple high power biconvex lens or the use of a combination of convex lenses mounted behind the mirror of the ophthalmoscope. Light was reflected by a mirror or directly towards the patient's eye from available daylight, a candle or an oil lamp.

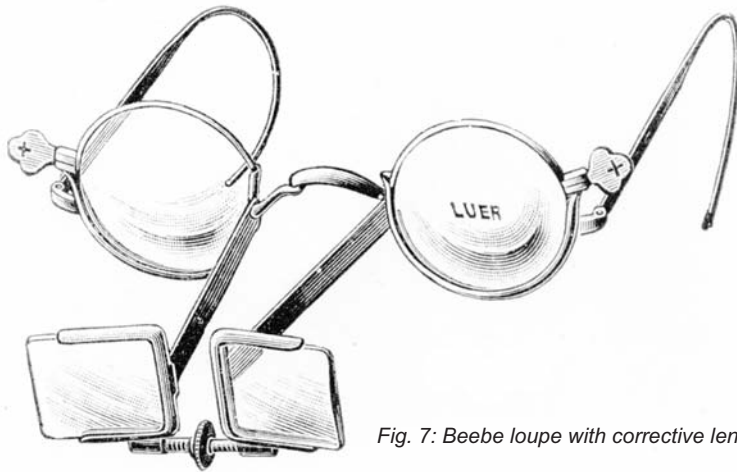

Fig. 7: Beebe loupe with corrective lenses

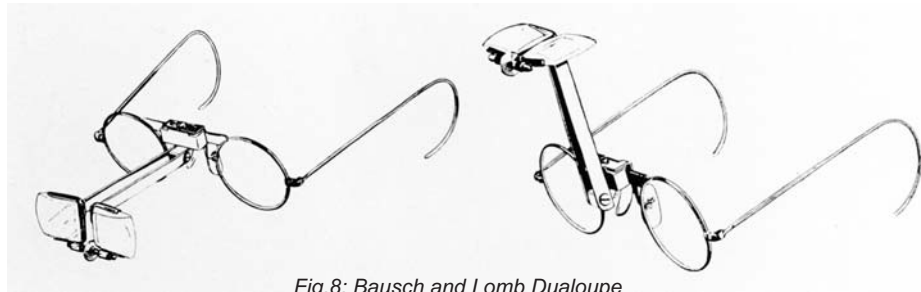

Fig.8: Bausch and Lomb Dualoupe

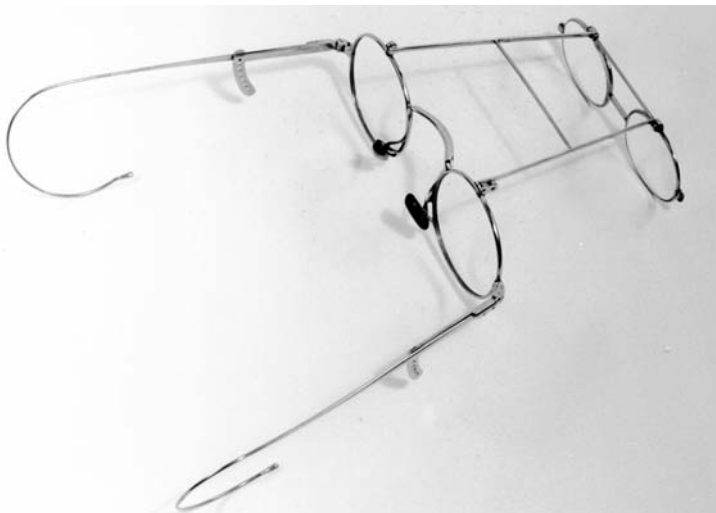

Fig.9: Duke-Elder loupe

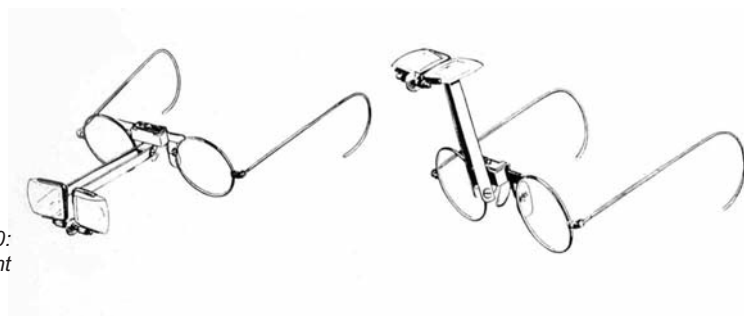

Fig.10:
Duke-Elder operating attachment

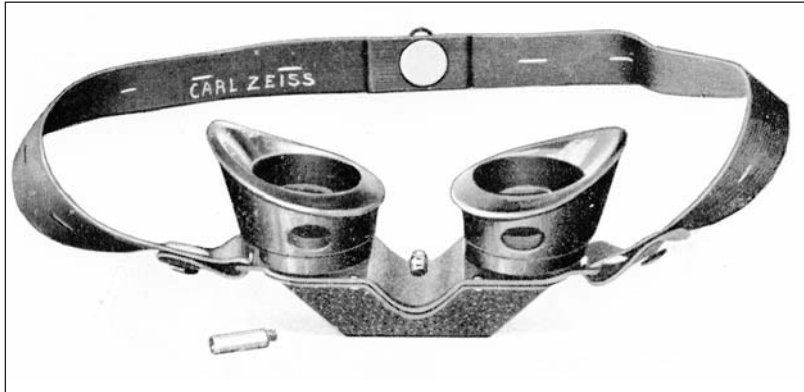

Fig.11: Zeiss Prism binocular loupe



Fig.12: Zeiss Prism binocular loupe on face frame



Fig.13: Open Galilean loupe

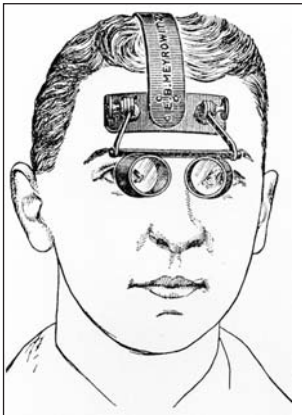

Fig.14: Jackson binocular loupe

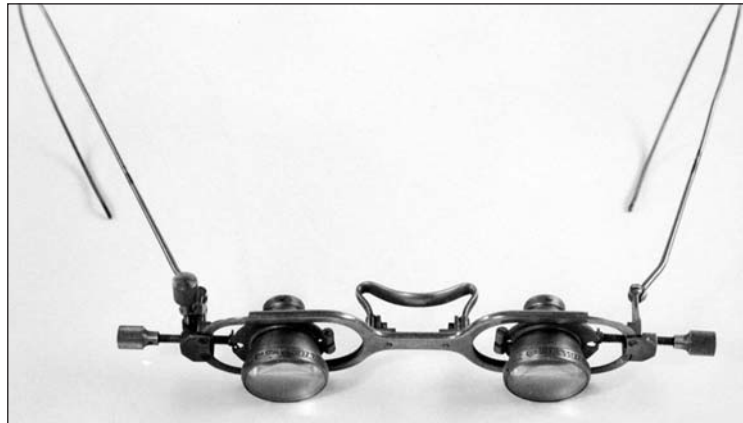

Fig.15: Zeiss 2x Galilean adjustable loupe

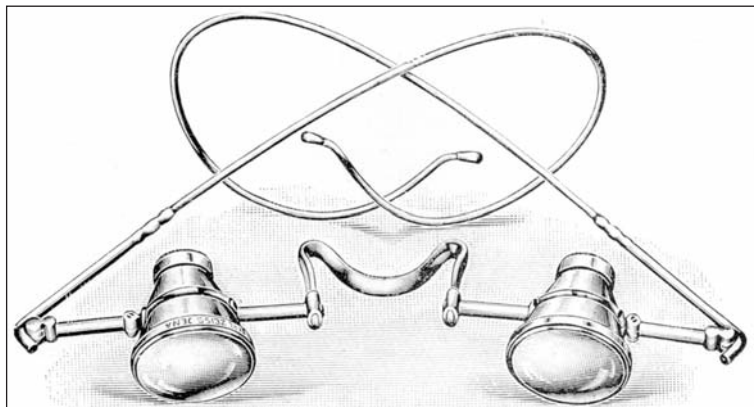

Fig.16: Zeiss 2x Galilean loupe

In 1855 Richard Liebreich (Fig.21) was the first to examine the eye with a (monocular) microscope 4 with which his table-mounted ophthalmoscope, that he had just designed, provided the essential structure

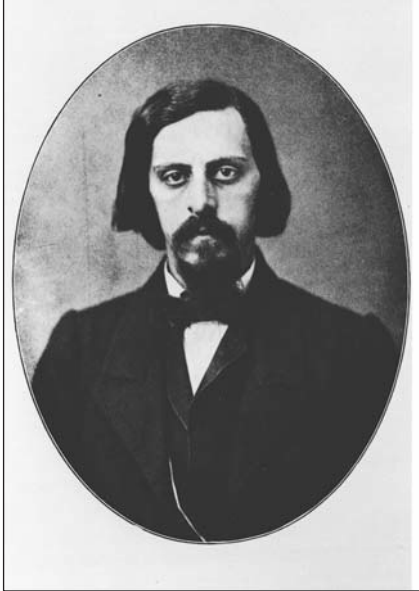

Fig.21: Richard Liebreich
1830-1917

(Fig.22 see p.42). Instead of the tube carrying at its end the perforated concave mirror for directing the light into the patient's eye in the indirect ophthalmoscopy mode, he replaced it with the body of a Schieck table microscope. This gave a very high magnification of up to 90x. Illumination of the cornea was from light focussed through a biconvex lens held to the side of the instrument (Fig.23 see p.42).

In 1863, Louis de Wecker (Fig.24) constructed his three-legged ophthalmo-microscope using a Hartnack monocular microscope system.⁵ De Wecker's microscope was hand-held but used the three legs to stabilise the instrument on the patient's head. It had a magnification range of 40-60x at a close working distance and was impractical for anything



Fig.24:
Louis de Wecker
1832-1906

other than examination of the cornea and anterior structure of the eye (Fig.25 see p.42).

Theodor Saemisch of Bonn can lay claim to be the first to use binocular magnification in ophthalmology in 1876.⁶ He employed a large 9 to 10 cm diameter single convex lens of six or eight dioptries, each eye looking through the outer diameter of the lens. Binocularity was aided by the base-in prism effect of the thick lens, but true stereopsis was not achieved.

For the first truly binocular system used in ophthalmology we must look to a device constructed in 1886 by H Westien for the

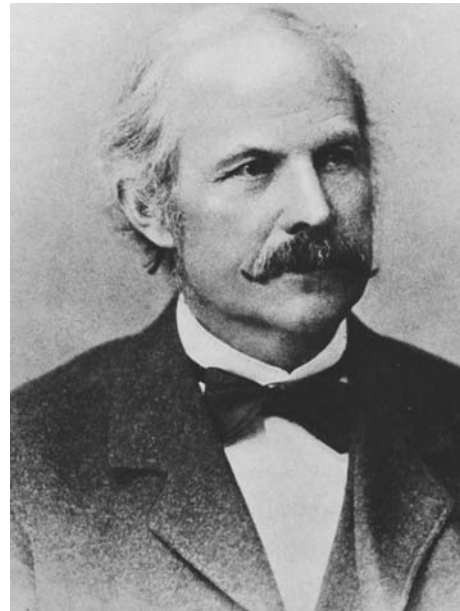

Fig.26: Karl von Zehender
1819-1916

zoologist F E Schultze and soon taken up and adapted by the Rostock ophthalmologist Karl Wilhelm von Zehender⁷ (Fig.26). Westien, also from Rostock, was the court mechanic. He combined two monocular Bruecke microscope bodies so that they converged, giving the operator a stereoscopic view of the patient's eye up to 10x magnification (Fig.27 see p.44).

The Bruecke loupe was a Galilean telescope arranged for a short working distance and was sometimes known as the Chevalier, after the man who had devised the instrument before Bruecke had knowledge of it.⁸ Illumination was achieved by focussing the light through a lens held on a jointed rod, as first devised by von Zehender (Fig.28 see p.44).

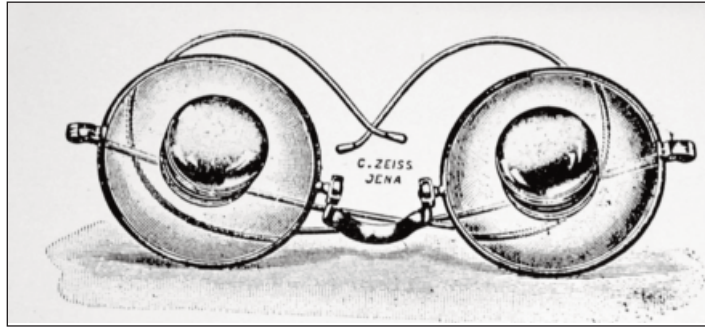

Fig.17: Zeiss 2x Galilean loupe



Fig.18: Keeler Fixed Galilean loupe

and personally prescribed from a specialist to suit each individual—and no-one else—can provide complete comfort throughout the day.

WIDE CHOICE OF MAGNIFICATION AND WORK DISTANCE

Whilst the major advantage of the Keeler Galilean loupe is its 2X magnification, there is a wide choice of magnification to suit the user's requirements. The magnification can be changed from the normal field to the magnified field without any loss of vision.

ES

computed for the loupe. The magnification is 2.5x, 3x, 4x, 5x, 6x, 7x, 8x, 9x, 10x, 12x, 15x, 20x, 25x, 30x, 35x, 40x, 45x, 50x, 60x, 70x, 80x, 90x, 100x.

7"

9x

2.5x

INFINITY

Fig.19: Keeler Galilean loupe range



Fig.20: Keeler adjustable Galilean loupe

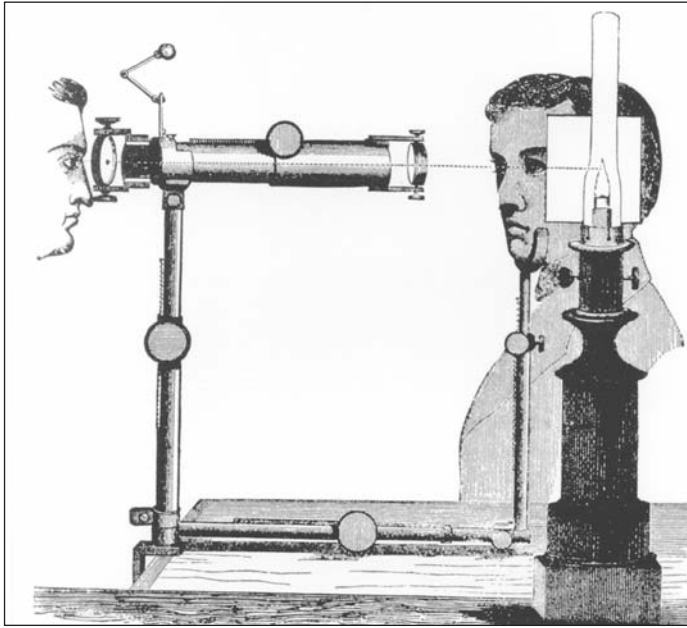

Fig.22:
Liebreich's Large Ophthalmoscope

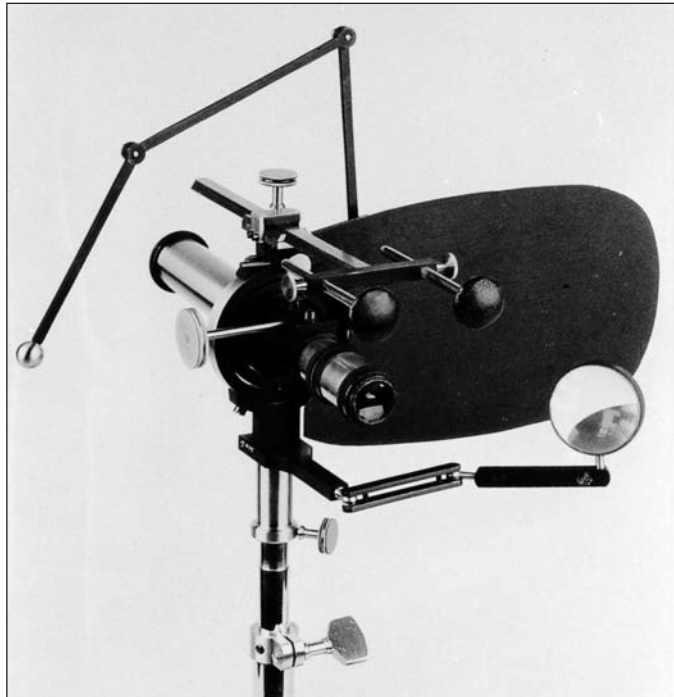

Fig.23:
Liebreich's monocular microscope

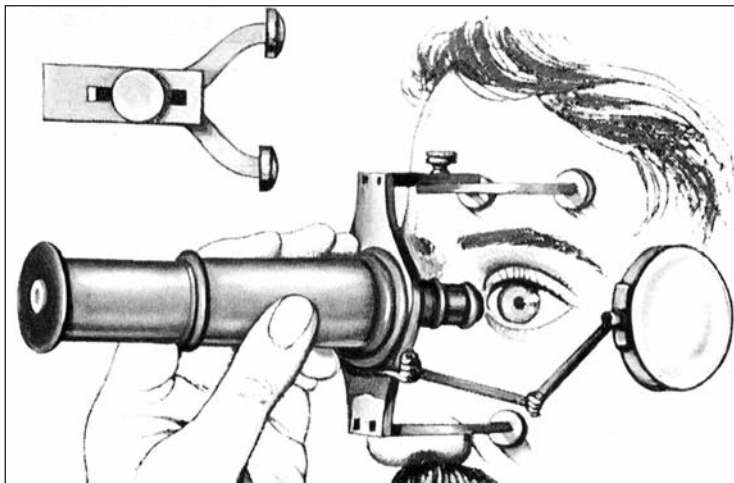

Fig.25:
de Wecker's monocular microscope

In 1887, Ludwig Laqueur of Strasbourg employed the Westien microscope for examining the eye, using a system of large-diameter condensing lenses in combination with a remotely positioned light source (Fig.29 *see p.44*).

In order to adapt the same optical principle for surgery, Westien mounted smaller telescope tubes, giving 5x to 6x magnification, to a head-mounted system (Fig.30 *see p.44*).

Theodor Axenfeld reported on this instrument in 1899.⁹ The combined weight of the telescopes and lamp of the Zehender binocular loupe was excessive at over 250g and for this reason it was not popular. There was no weight problem when it was mounted on a column with chin rest, but of course this could not be used in surgery. The same fate, due to its weight, befell the R & J Beck surgical loupe of 1908 (Fig.31 *see p.46*) which had a magnification of 3x at a working distance of 7.5 cm and was described by its originator, L Buchanan of Glasgow, as a portable microscope.¹⁰ The interpupillary distance could be changed by moving the left telescope in its angled holder. The binocular loupe was held on the head with a strap attached to padded forehead rests, with a further padded rest, placed at the brow of the nose.

Carl Zeiss at this time produced a binocular telescopic magnifier which was a combination of simple magnifiers and a prism telescope giving a range of magnification of 2-3x. This unit with electrical illumination was either attached to a headband, (Fig.32 *see p.46*) or mounted on a floor stand (Fig.33 *see p.46*).

In the same year, (1897) the first significant binocular microscope for examining the eye was designed by Siegfried Czapski



Fig.34:
Siegfried Czapski
1861-1907

(Fig.34) and F Schanz and manufactured by Carl Zeiss of Jena 11 (Fig.35 *see p.46*). Czapski, who had succeeded Ernst Abbe at Carl Zeiss, designed the microscope with a system of erecting eyepieces with porro prisms, together with pairs of interchangeable objectives and eyepieces, to give a wide choice of magnification. Czapski improved on the binocular corneal microscope that H Aubert had presented to the Ophthalmological Congress in Heidelberg earlier in 1891. A rather inadequate low-voltage diffusely radiating lamp was added to the Czapski microscope. Later the lamp was attached to a Lucanus curved



Fig.37: Allvar Gullstrand
1862-1930

rail (Fig.36 *see p.47*) which was in the form of a quadrant that always left space on one side of the microscope available for observations on the eye. It also admitted light being directed upwards when the quadrant was placed in a vertical or oblique position. In 1911 W H Leudde modified the microscope by adding a 6-volt tungsten lamp with double condensing system, and placing it on a ball and socket joint attached to an extendable arm. If one was to trace the origin of the modern binocular ophthalmic operating microscope, it would seem natural to start with the Czapski microscope. However, in 1911, a bril-

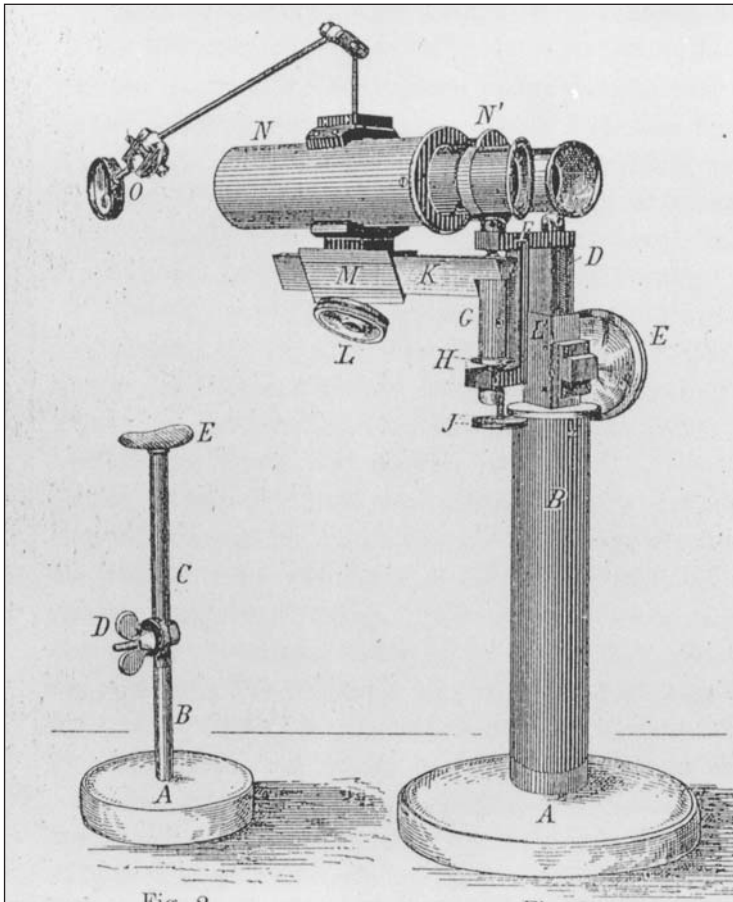

Fig.27:
Westien's binocular
microscope 1886

Fig.28:
Westien's binocular microscope with
illuminating lens

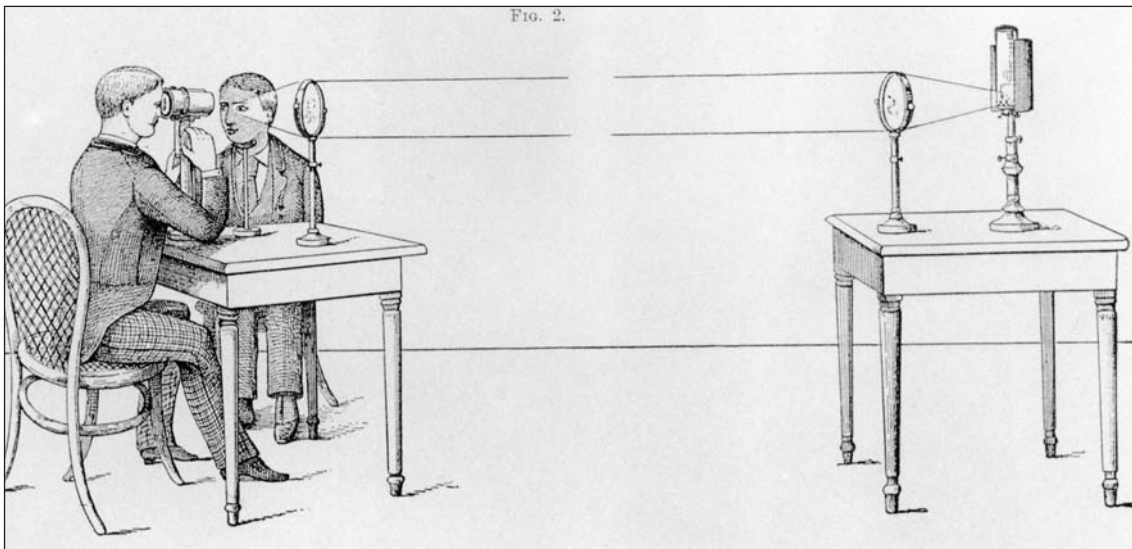

Fig.29: Laqueur's binocular mi-
croscope arrangement

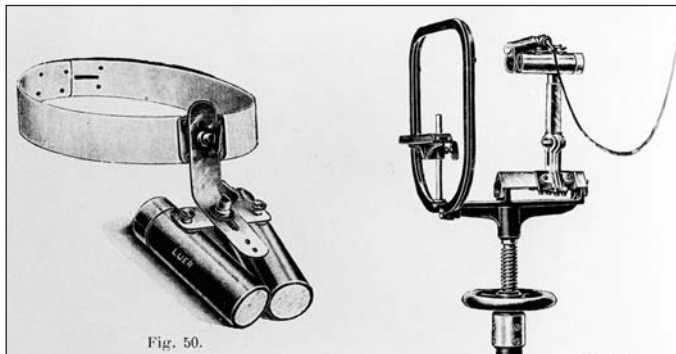

Fig.30:
Westien/Zehender
binocular surgical loupe 1899

Fig. 50.

liant innovator of optical systems and Nobel Prize Laureate, the Swede Allvar Gullstrand (Fig.37), introduced the first instrument of its kind, the “Slit Lamp” (Fig.38 see p.47) or as it was later termed in 1925 by Jacques Mawas of Paris, the ‘Biomicroscope’.¹²

So in 1911 ophthalmic surgeons had in their hands the essential ingredients for a binocular operating microscope for ocular surgery, but with one major drawback: the free working distance was too short for surgery. As will be seen, there were other reasons why ophthalmic surgeons were reluctant to use such an instrument in the operating theatre, but these do not fully explain why it took another 40 years for the first production model to be manufactured.



Fig.39: Carl-Olof Nylén

Otologists however had seen the benefits that magnification could bring to their procedures when Carl-Olof Nylén from Sweden (Fig.39) described (1954)¹³ how he first started using experimentally, in 1921, a monocular Brinell-Leitz microscope giving 10-15x magnification (Fig.40 see p.47) for labyrinthine fistula operations on temporal bone preparations from human beings and living animals. Later, Nylén took advantage of an opportunity to use an otomicroscope especially constructed by engineer N Persson and himself (Fig.41 see p.47). However, it was Nylén’s chief, Professor Gunnar Holmgren who, in 1922, started the development of modern microsurgery by developing and popularising the use of a Zeiss binocular microscope (8-25x magnification) which had been adapted for fenestration operations (Fig.42 see p.48).

This microscope, until 1938, had a very small field of view of 6-12mm and a working distance of 7.5cm.

Between Nylén’s use of a monocular microscope in 1921 and the first reported use of a binocular microscope in ocular surgery in 1946 numerous microscopes were manufactured. In fact there were more than eight different manufacturers involved including Ernst Leitz, Carl Zeiss, Bausch and Lomb and R & J Beck.

Seven years later, when Zeiss started working with ophthalmologists in 1953, no less than nineteen surgical microscope designs had appeared, the first two of these being monocular. As has already been stated, it was Holmgren who had popularised the use of high-power magnification with the binocular microscope in surgery. The otologist’s requirements in a microscope were somewhat different to those of the ophthalmologist. Maybe it was the small field of view and short working distance that had deterred the ophthalmic surgeon in the first instance, or the potential slowing down in well-established procedures, but the fact remains that binocular microscopes, a number on floor stands, were being used by surgeons, mainly otologists, for thirty two years without the ophthalmologist becoming involved.

The Dawn of the Modern Ophthalmic Microscope

The title of “*father of ophthalmic microsurgery*” goes to Richard A Perritt of Chicago. He reported his use of a microscope for various surgical procedures as early as 1946 and was the first ophthalmologist, on record, to use a microscope in ocular surgery on a systematic basis. Perritt used a modified Bausch and Lomb (1942) bench-mounted dissecting microscope (Fig.43 see p.48) with spot illumination, which he placed on a trolley at the side of the operating table. For operations he swung the magnification head 180o over the patient’s head, the weight of the microscope base keeping the arrangement stable. The microscope had a short working distance of 12.5cm. There was a choice of magnification by changing eyepieces to give 3.5x, 7.0x and 10.5x. According to Perritt, this microscope was shown in public at the 1950 corneal surgery course of the American



Fig.31:
Buchanan binocular surgical loupe by
R and J Beck 1908

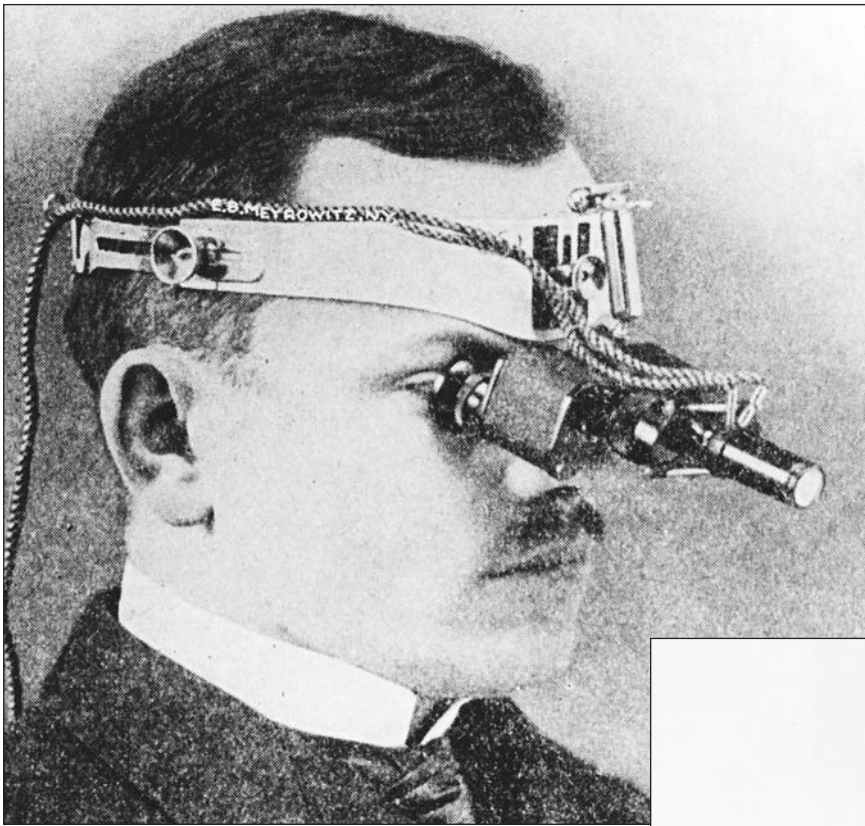

Fig.32:
Carl Zeiss headworn
binocular prism loupe

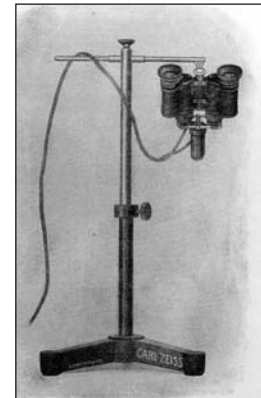

Fig.33: Carl Zeiss stand
mounted binocular prism
loupe

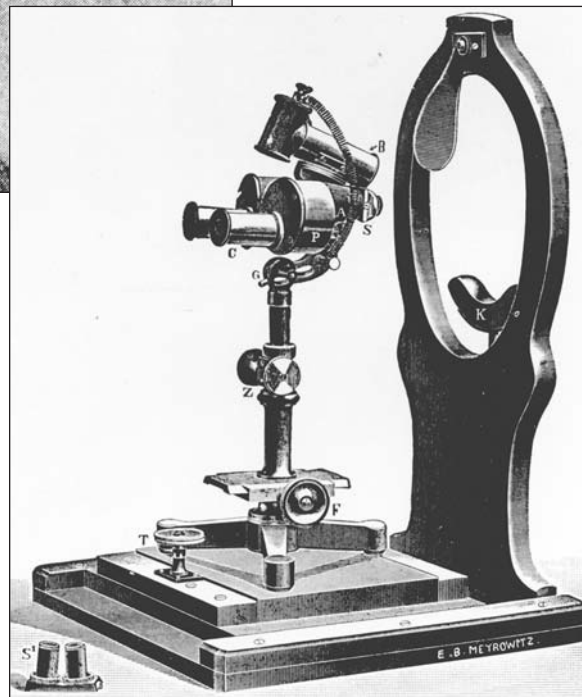

Fig.35:
Czapski's corneal microscope



Fig.36:
Czapski's corneal microscope with Lucanus rail

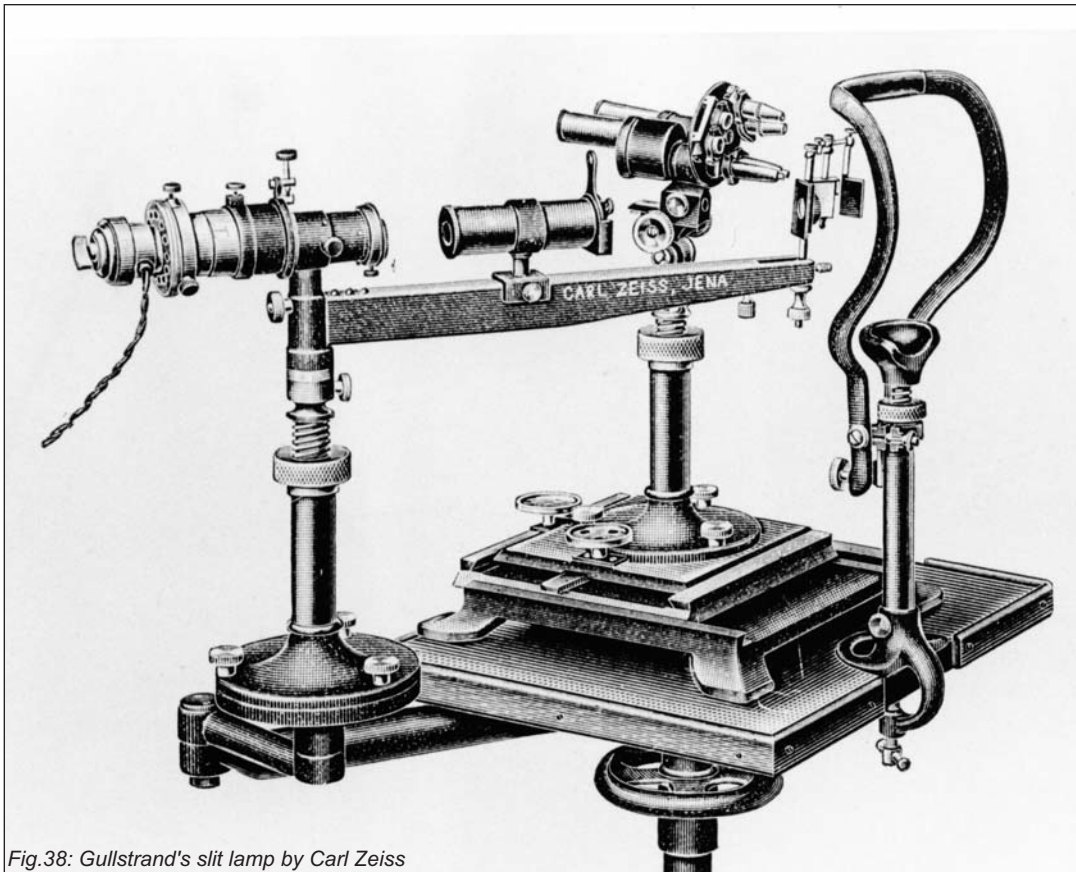

Fig.38: Gullstrand's slit lamp by Carl Zeiss



Fig.40:
Brinell-Leitz
monocular
microscope

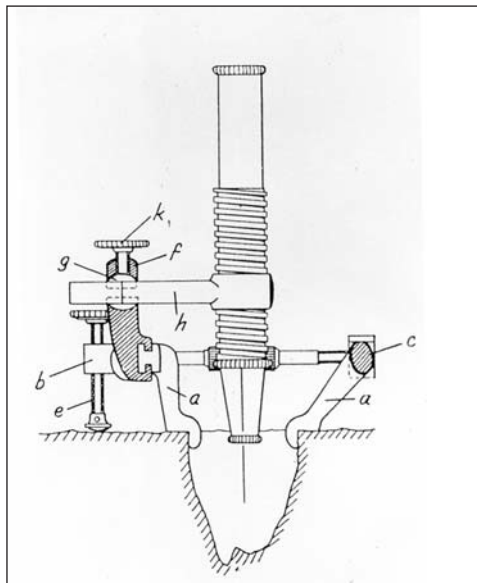

Fig.41:
Nylén-Persson
monocular microscope

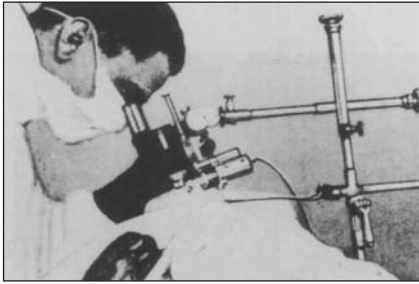

Fig.42:
Holmgren using Zeiss binocular microscope

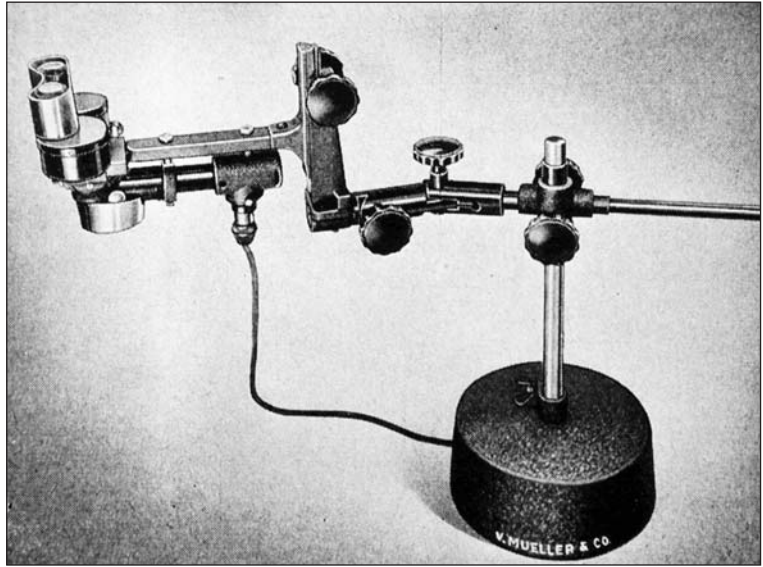

Fig.43:
Richard Perritt's
binocular microscope by
Bausch and Lomb

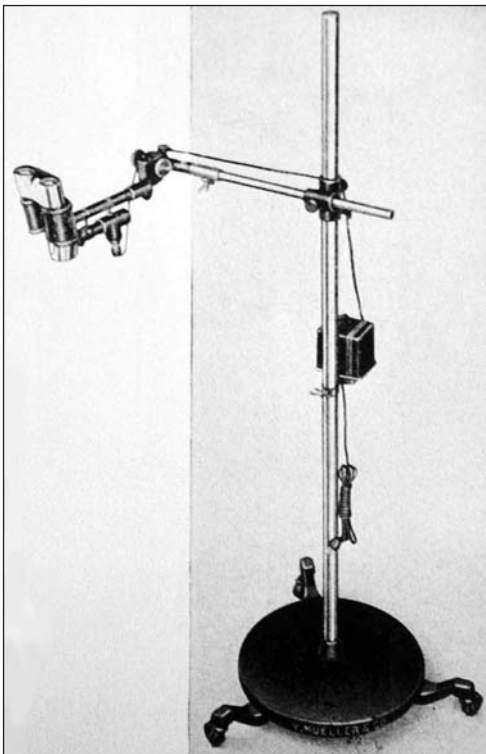

Fig.44: Shambaugh's binocular microscope by
Bausch and Lomb



Fig.46: Zeiss OPMI
microscope 1953

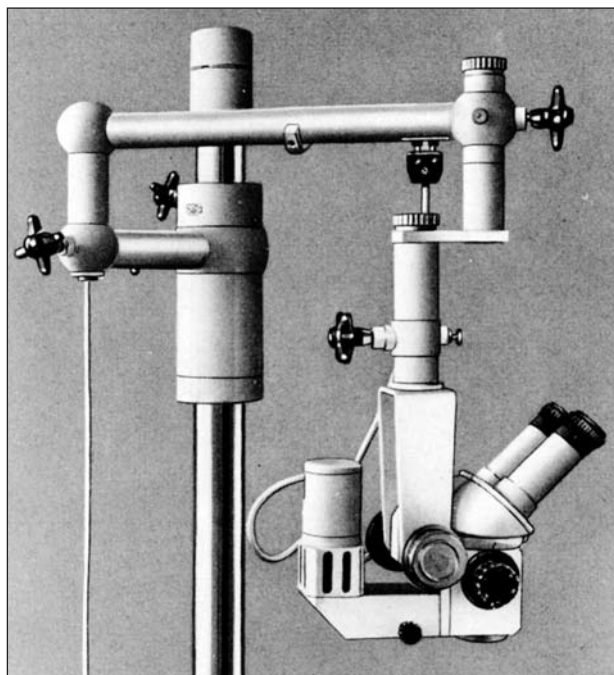

Fig.48:
Zeiss OPMI rotating on axis microscope

Academy of Ophthalmology. The Bausch and Lomb instrument bearing the name 'Perritt Corneal microscope' appeared in the 1951 catalogue of V Mueller & Co, Chicago. In the 1956 V Mueller catalogue there is an illustration of G E Shambaugh's fenestration microscope on a floor stand (Fig.44 see p.48). It is the same Bausch and Lomb (Perritt) microscope, but with a longer working distance of 20cm. At the 18th International Congress of Ophthalmology in Brussels in 1958, Perritt gave a paper on micro-ophthalmic surgery, in which he briefly described his earlier experiences with the microscope used since 1846.¹⁴

THE CARL ZEISS COMPANY

In 1954 Dr Hans Littmann PH. NAT.D., M.D.(Hon) of Carl Zeiss (Fig.45), Oberkochen, published a paper¹⁵ announcing the launch five years before of an operating microscope used in colposcopy, and



Fig.45: Hans Littmann 1908-1991

shortly afterwards in otology, for surgery of the inner ear. Littmann had developed a bench-mounted binocular dissecting microscope for Zeiss and in 1948, a slit-lamp corneal microscope with rapid, click-stop change in magnification without the need to refocus. The slit-lamp microscope also had coaxial illumination. Littmann quickly realised that this instrument only needed a suitable stand-mount for it to be used in ocular surgery. This 'otological' microscope was used by the early pioneers of ocular surgery, such as Harms,

Mackensen, the Barraquer family, Dannheim, Becker, Roper-Hall, Troutman and others.



Fig.47: Heinrich Harms

One year after the introduction of the Zeiss Opton microscope in 1952 (Fig.46 see p.48), Professor Heinrich Harms of the Eye Clinic of Tübingen University (Fig.47), reported to the German Ophthalmological Society in 1953¹⁶, the use of this instrument for the surgical repair of traumatic lesions of the eye and for keratoplasty. In reviewing his early experiences at the 1st International Symposium on Microsurgery of the Eye held at Tübingen in 1966, Harms recounted how he had sought a means of developing a suitable support to suspend the slit-lamp corneal microscope which he and his teacher Professor Löhlein had been using for severe traumatic ocular lesions during world war II. Unknown to Harms, Ignacio and José Barraquer were also using the same microscope and reporting their initial experiences. The microscope was used by José Barraquer in Buenos Aires in April 1953 during the 10th Argentine Ophthalmological Congress.

The Zeiss Operating Microscope¹⁷, adapted for ocular surgery by Harms, had an interchangeable tube for straight or oblique viewing, the eyepieces being slightly convergent to assist binocular fusion. Magnification change was manual, and there was a choice of five powers using a Galilei changer without loss of focus. Focussing was also manual. Illumination of the eye field was by a coaxial lamp of 6 volt 30 watt. The microscope was-

mounted on an articulated arm attached to a solid moveable stand. Shortly after this, a new arm designed especially for the ophthalmic surgeon was introduced. This allowed the microscope to be rotated around its own axis, thereby avoiding tedious realignment and refocussing (Fig.48 see p.48). A combination of eyepieces and two objectives of 125 mm and 200 mm focal length gave a wide choice of click-stop magnification from 6x to 40x.

This microscope was also designed for a range of surgical procedures, including otoscopy, dermatology and colposcopy, where a longer working distance was available. The most usual set-up for ophthalmic procedures was the inclined binoculars with 12.5x eyepieces and objective lens of $f = 200$ mm. This combination gave a choice of magnification (diameter of visual field in mm) of 4x (50mm), 6x (32mm), 10x (20mm), 16x (12mm) and 25x (8mm). The coaxial illumination covered approximately 32 mm of the surgical field. For changing the magnification, a sterilised metal or rubber cap was fitted and sterile sheets covered the ocular



Fig.49: Gunther Mackensen

tubes for easy adjustment without getting contaminated. It was from this basic surgical microscope, itself having evolved from the corneal microscope with slit lamp, that many additions and adaptations were made by Zeiss and others during the next ten years.

Throughout the early years of the development of the ophthalmic surgical microscope, Gunther Mackensen (Fig.49) assisted Harms at the Eye Clinic in Tübingen, and the team of Harms and Mackensen became syno-

nymous with the development of microscopes and microsurgery. They co-authored "*Ocular Surgery under the Microscope*" in 1966.¹⁷

The coaxial illumination provided by the first Zeiss microscope was not ideal for a number of ocular procedures, not only because of its glare but for its tendency to flatten the image of the eye, losing shadow detail and thereby reducing depth perception. In addition, any instrument introduced into the field cast its own shadow. Lateral illumina-



Fig.50:
Henri Dekking 1902-1966

tion was soon added by mounting a lamp on an arm attached to a ring circling the objective holder.

In January 1956 Henri M Dekking of Gröningen (Fig.50) in Holland reported¹⁸ on a simplification of the Zeiss surgical microscope. Dekking contended that a single magnification of 10x was all that was required and he stripped out the elaborate magnification changer. In place of the coaxial lamp with its 33 mm of illuminated field, he had his own built-in light source using a condensing lens system, which gave a wider area of illumination of 45 mm (Fig.51 next page).

Dekking also identified another disadvantage in the original Zeiss surgical microscope. This was the inability of the surgeon to focus or make small adjustments in the horizontal and vertical directions whilst looking through the microscope and keeping his hands free at all times. Dekking's solution was to build a new support stand where the X-Y horizontal movements could be made by the surgeon rotating wheels with his feet, giving lateral and transverse movements. Focussing was achieved by movement of the surgeon's knee against a long

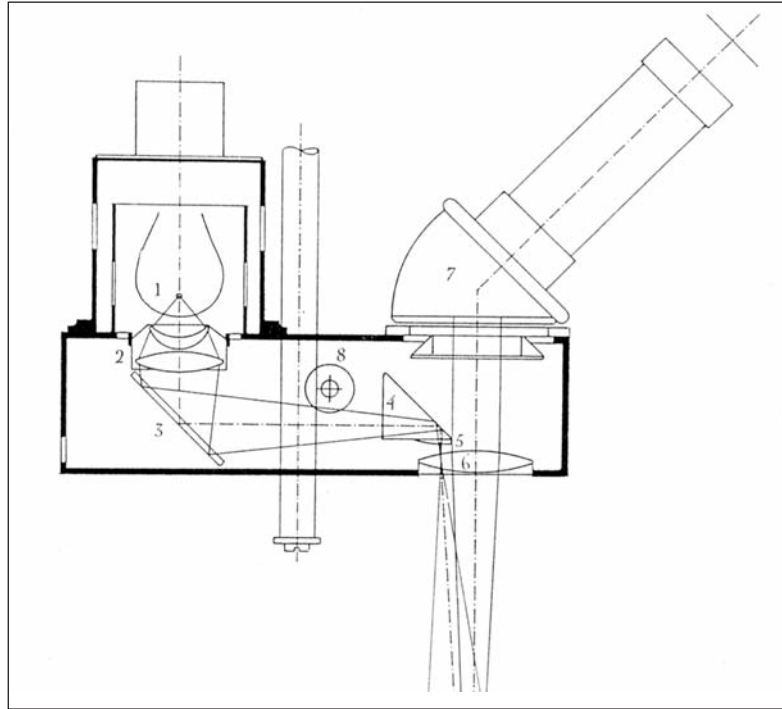

Fig.51:
Dekking's light system on
Zeiss microscope OPMI

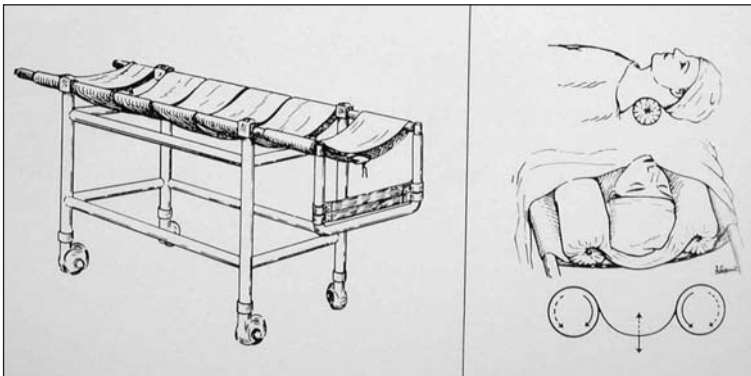

Fig.52:
Barraquer's bolster headrest and trolley

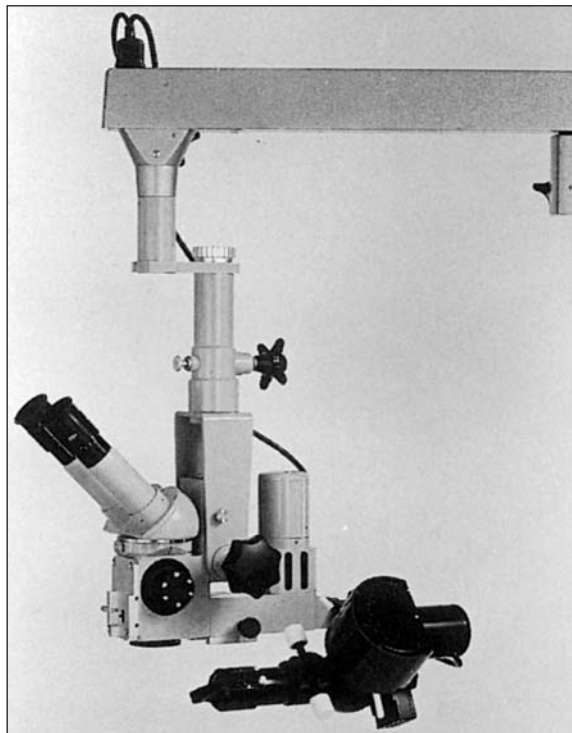

Fig.53:
Zeiss microscope with slit lamp attachment

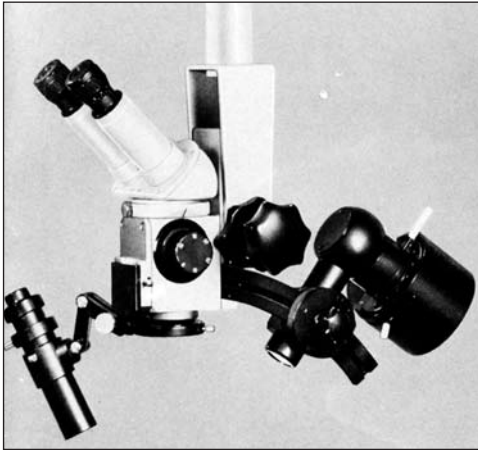

Fig.54:
Zeiss microscope with Harms arm for slit-lamp

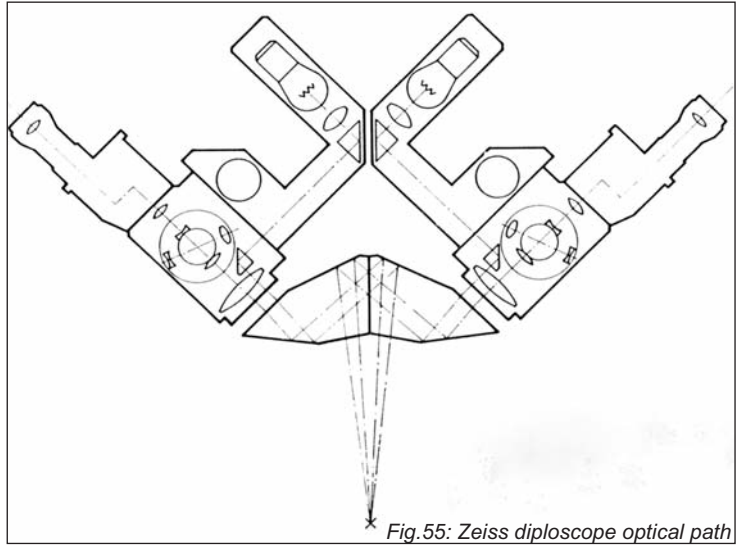

Fig.55: Zeiss diploscope optical path

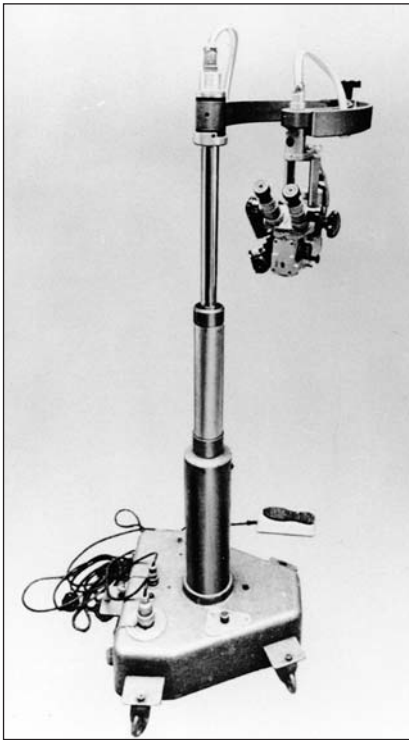

Fig.57:
Pitts Crick microscope on
Keeler stand

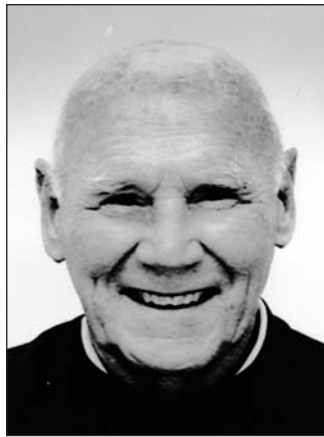

Fig.56: Ronald Pitts Crick



Fig.58: Dermot Pierse

lever half-way up the support column. Barraquer's bolster headrest and trolley In an attempt to stabilise the patient's head, Dekking devised a padded head-clamp consisting of a three-sided wooden box which fitted into the existing fixation clamp at the head of the operating table. This device succeeded in giving firm fixation to the patient's head throughout the operation. In a similar vein, Montague Ruben (London) in 1959 designed¹⁹ an operation table head pillow which, in a similar product, was to become an essential ingredient of Dermot Pierse's microscope system a few years later.

At the Barraquer Clinic a bolster headrest was employed which stabilised the patient's head. The height of the head could be adjusted by rolling or relaxing the connecting strap wrapped around the bolsters²⁰ (Fig.52 *see p.51*). An additional advantage of Dekking's head-clamp was that it could be used as an arm/hand rest for greater steadiness of the surgeon's movements. A further contribution to the evolution of the surgical microscope by Dekking was not a practical one, but an addition to the language in this branch of ophthalmic surgery. In the paper he wrote in 1956¹⁸ the term 'microsurgery' was used for the first time.

Another early user of the original Zeiss surgical microscope was Bernard Becker of St Louis. In 1956 he reported²¹ having used the instrument for two years in surgery principally for goniotomies, discissions, corneal transplants, repair of lacerations and the removal of foreign bodies. Interestingly, he does however state that "the use of the instrument in routine cataract extraction has proved disappointing thus far because of the limited visual field and awkwardness of grosser movements".

By the end of 1956, José Barraquer had adapted a slit lamp to the Zeiss microscope²² and added mechanical fine focussing operated by footswitch (Fig.53 *see p.51*). This worked well when the microscope was in the vertical position. With the addition of a minus 10D lens, Barraquer's surgical slit-lamp microscope had a longer working distance of 15cm than the combination of slit-lamp and surgical microscope that Littman had designed for biomicroscopy of supine patients. Barraquer advocated the use of slit-

illumination to observe the optical section. When the slit was completely open, lateral illumination, with its many advantages including improvement in depth perception, was provided. The slit lamp was attached to the microscope with a special arm allowing the instrument to be used in any position. At the suggestion of Harms, Zeiss constructed a curved arm so that the slit-lamp light came not from the usual position at the side of the surgeon but was turned through 90° opposite the surgeon (Fig.54 *see p.52*).

In 1961 Littmann developed a system of two microscopes to allow an assistant to view the same surgical field as the surgeon. The microscope was known as the Diploscope and was designed for teaching and demonstration (Fig.55 *see p.52*). This new arrangement consisted of two surgical microscopes attached opposite to one another, and by means of a series of prisms which enabled both operators to share the same illuminated field of view but from opposite sides. The assistant or observer could choose a lower magnification than the surgeon and also focus the microscope independently. The usual working distance from the base of the objective was 23cms, but this could also be 15cms. With the combination of the longer objective and the 20x eyepieces a choice of magnification of 6x, 10x, 16x, 25x or 40x was available. Using the shorter objective each magnification was increased by 20%.

Harms was the first to use this instrument in ocular surgery, and it fulfilled an increasing demand by students to be trained in microsurgery. The students usually chose a smaller magnification than the surgeon. Harms emphasised the importance of setting up the Diploscope accurately so that there was a superimposition of each visual field of both microscopes at various magnifications. Harms found several deficiencies in this instrument: its bulkiness, focal working distance and the fact that the surgeon and assistant had to operate opposite each other. In 1966 Harms developed with Zeiss a double microscope, the OPMI 5, an altogether more effective instrument.

THE KEELER COMPANY

The Keeler Company's initial involvement in the development of the ophthalmic

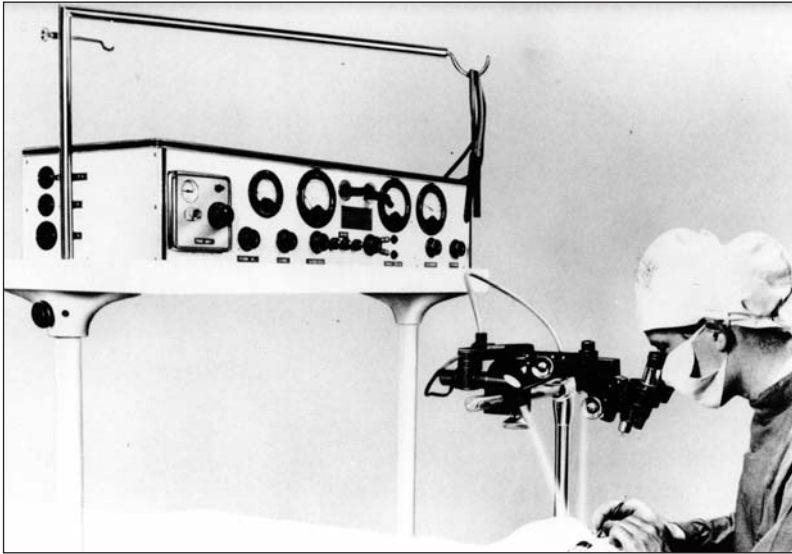

Fig.60: Keeler-Pierse microscope on head-rest base

Fig.59: Keeler-Pierse binocular microscope



Fig.62: Keeler-Troutman stereozoom microscope by Bausch and Lomb



Fig.63: Keeler-Troutman zoom microscope on base

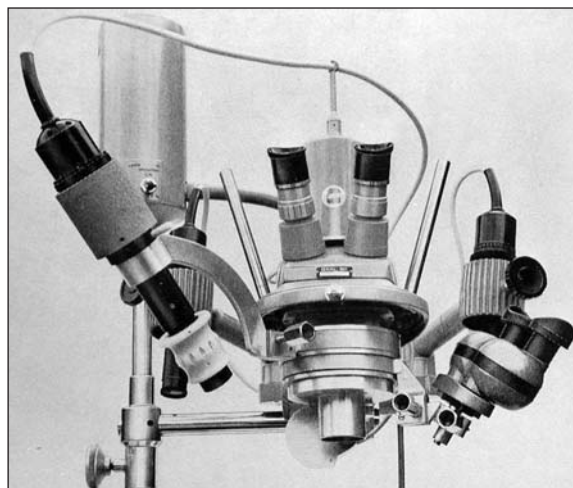

Fig.64: Keeler-Troutman zoom microscope with slit lamp

surgical microscope was with Ronald Pitts Crick of London (Fig.56 see p.52). In 1956, Pitts Crick, as a result of experience gained originally in ocular trauma, realised that it was foolish to examine patients with the slit-lamp microscope before surgery and again examine the results post-operatively, but not during the operation, when it could influence the conduct of the procedure. Experience with the operating microscope also showed that the only limitation in carrying out fine manipulations was magnification; and the poor quality of the micro instruments, also that average proprioception was well able to cope with anything that could be accurately visualised.

After the initial use of a hand-held binocular microscope in a sterile towel, one mounted on a special stand was manufactured by Keeler and shown at the Oxford Ophthalmological Congress in 1958.

There followed several months of the production of prototypes of a floor-mounted operating microscope employing, at first, pneumatic and then more accurate electric focussing mechanisms with foot control. With increasing experience the microscope was used for the whole or part of almost all eye operations. The 'steaming up' of oculars was avoided by an electrical warming device.²³ The use of a Beck microscope pod was followed by mounting the original Zeiss surgical microscope head on the same stand which also included integral illumination (Fig.57 see p.52). One feature that failed to be incorporated was Pitts Crick's suggestion of an interpupillary distance gauge which would have allowed the oculars to be preset precisely to the surgeon's individual measurement prior to the operation.²³ The microscope was characterised by its horse-shoe support arm which gave great stability to the whole apparatus and the head of the patient immobilised by a Ruben pillow.

The Pitts Crick microscope was shown at the 18th International Ophthalmological Congress in Brussels in 1958, by Keeler, it never went into production. The phase 2 prototype microscope was used extensively at the Royal Eye Hospital, London from 1958 and registrars were trained in its use. Becoming surplus to requirements in 1982, it was presented to Dr Abhay Vasavada FRCS FRCOphth Senior Registrar at Kings College

Hospital, on his return to India as a consultant. It is still in daily use in his department at the Cataract and IOL Research Centre in Ahmedabad. In the early part of 1960, Dermot Pierse of London (Fig.58 see p.52), an inveterate and brilliant inventor of a wide range of surgical instruments and equipment, set his mind to the development of a microsurgical system, working with the Keeler Company. He recognised early on, like Dekking and Pitts Crick, that one of the barriers to the successful use of a surgical microscope was the movement of the patient's head in relation to the microscope. He overcame this with the novel idea of combining the microscope and operating table head-rest in a fixed relationship. A shaped pillow made of hard rubber, similar to the Ruben pillow already referred to, was placed in a rectangular metal base from which an arm holding the microscope was fixed. This arrangement ensured that the relationship between the patient's eye and the microscope was always constant and stable. The first Keeler-Pierse prototype model used an R & J Beck microscope of the Greenhough design with interchangeable eyepieces which gave a choice of magnification of 6x, 10x or 13x (Fig.59 see p.54). Illumination was from one oblique lamp. Attached to the head-rest metal base were two adjustable arm-rests and a tray for instruments. The head rest base with attached microscope was placed at the end and on top of the operating table. In a later model the microscope unit rested on a Krahn hydraulic table, the complete unit was pushed up to the end of the operating table, and the head flap of the table was lowered. With both models the microscope could be in position prior to the patient being supported then lifted on to the pillow. This microscope was shown for the first time at the American Academy of Ophthalmology and Otolaryngology Exhibition in 1961.

When the Pierse Eye Operating Table Head went into production it included two 18-watt operating lamps giving strong, oblique, homogeneous and shadow-free illumination on the eye. The lights could be left in position when the microscope head was swung out of the field of observation (Fig.60 see p.54).

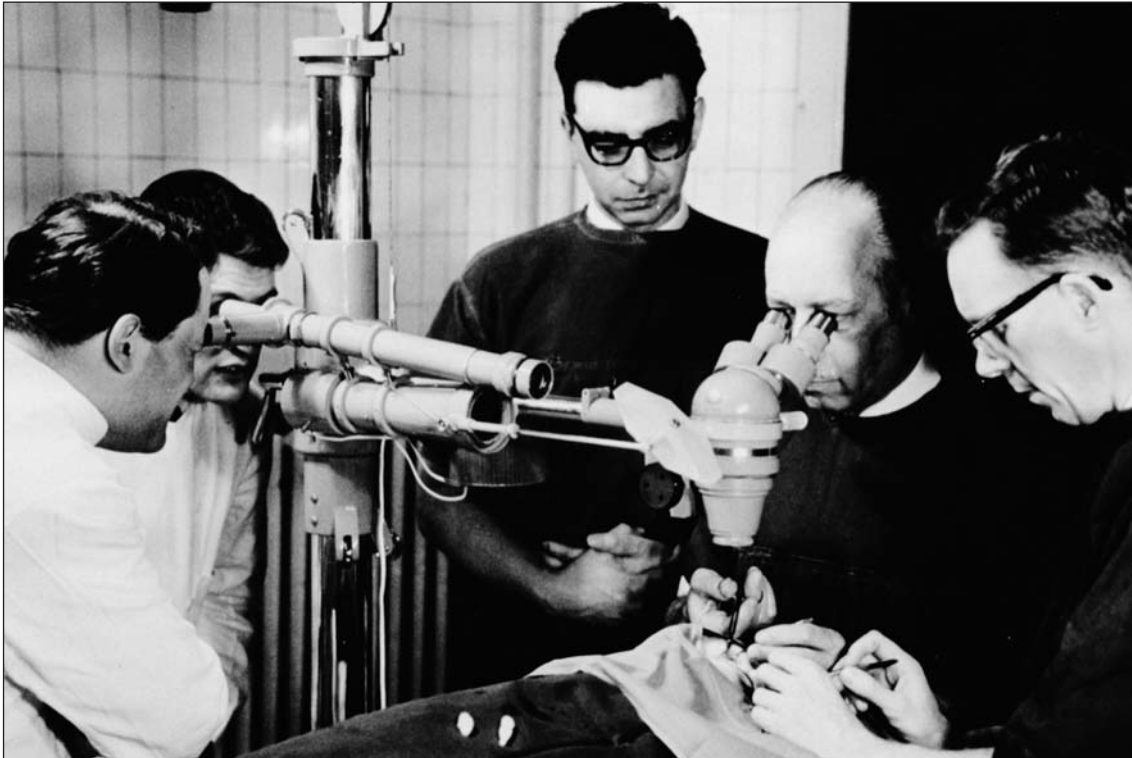

Fig.65: Dekking operating with Olympus zoom microscope. Jan Worst assisting

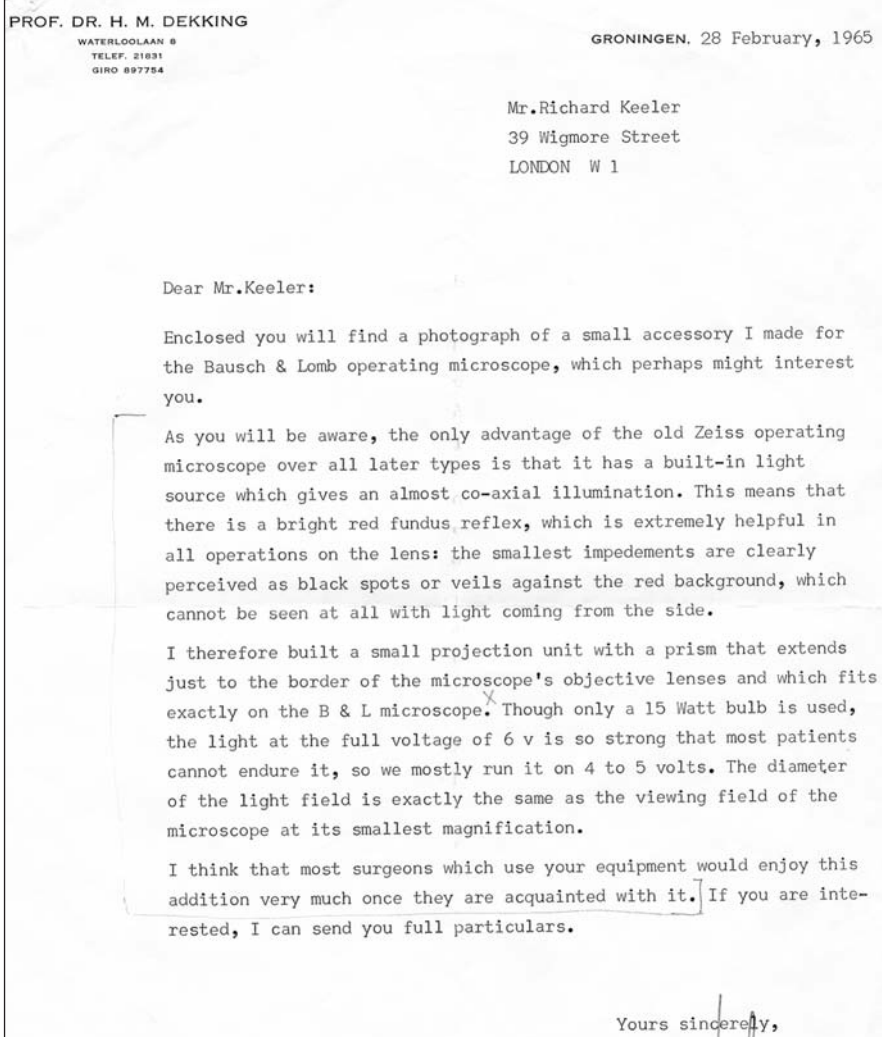

Fig.66:
 Original letter from Dekking

THE FIRST MOTORISED ZOOM MICROSCOPE FOR SURGERY

The next significant development in the Keeler-Pierse unit was the substitution of the single magnification R & J Beck microscope for a Bausch and Lomb zoom microscope.

The origin of the aberration-free zoom lens²⁴ occurred shortly after the Second World War when the British Broadcasting Corporation (BBC) asked the optical firm W Watson and Sons to produce a zoom lens for use in televising sporting events. Dr Harold H Hopkins, senior lecturer in technical optics at Imperial College, London who was a consultant to W Watson, in due course successfully tested his invention at Lord's Cricket



Fig.61: Richard C Troutman

Ground in 1948. In a further three years the lens was perfected. It was at this time that Hopkins was also acting as an optical design consultant to the Keeler Company.

Little was he to know that his invention of the zoom lens would enable Keeler to launch the first surgical microscope with motorised zoom optics sixteen years later. As a matter of record Watson and Son was one of the companies to produce a surgical microscope as early as 1948.

The Bausch and Lomb StereoZoom microscope, with manual magnification change, had been available for some time as a laboratory microscope. Richard C Troutman of New York (Fig.61) had tried unsuccessful-

fully to adapt it to a Zeiss stand column²⁵ but when he saw the Keeler Pierse unit at the American Academy of Ophthalmology in Las Vegas he suggested to Charles Keeler that a Bausch and Lomb StereoZoom microscope, with an uninterrupted magnification range of 3.5x to 15x, would be highly desirable for this unit.²⁶

Keeler took up the idea. With the addition of a minus lens attached to the end of the standard zoom power-pod to increase the working distance to 16 cm and motorisation of the magnification change knob, operated by a heel and toe footswitch, the first motorised zoom microscope for use in any branch of surgery was launched in 1963. For the first time in ocular procedures, the surgeon could select the most suitable magnification without taking his eyes or hands away from the operating site. The 'sealed optics' zoom microscope was now mounted on the Keeler Pierse head-rest base instead of the single magnification Beck microscope, and in addition more powerful, obliquely mounted lamps were provided (Fig.62 see p.54). The unit had now become significantly heavier with the transformer mounted on a column five feet above the ground to conform to operating theatre electrical safety regulations.

At Troutman's suggestion the microscope was given its own dedicated hydraulic base. The 'jaw' between the head rest and the hydraulic base could now envelop the first part of the operating table or stretcher when pushed up to it (Fig.63 see p.54).

By 1965 the Keeler Micro Ophthalmic Surgical Unit had incorporated further important additions.²⁷

The call for fine focussing was met with the attachment of a motor-driven eccentric cam attached to the objective lens of the zoom unit. This was operated by a simple footswitch on a continuous one-direction-change basis so that the surgeon lifted his foot when he had achieved focus. In addition to the more powerful oblique 30-watt lamps, slit illumination had been added. There was also a simple, fixed 6x magnification microscope attached on a ring of the microscope pod which could be rotated to the most advantageous position for the assistant or observer (Fig.64 see p.54).

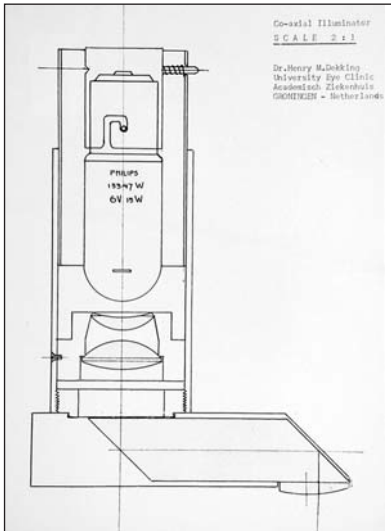

Fig.67:
Diagram of Dekking light attachment fitted to Keeler zoom power-pod



Fig.68.
Dekking light attachment

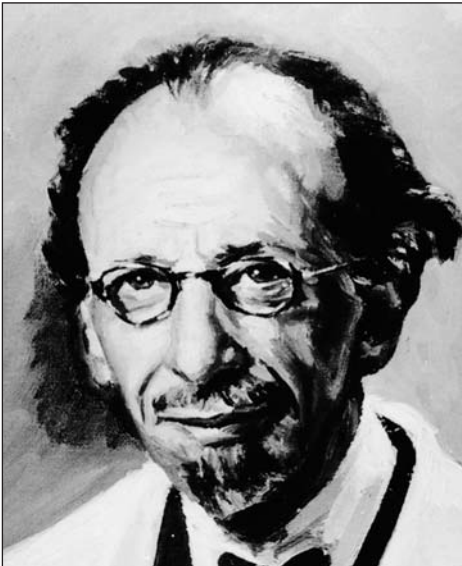

Fig.70:
Ignacio Barraquer
1884-1965



Fig.71:
José Barraquer
1916-1998



Fig.72:
Joaquin Barraquer
*1927

At about this time Dekking had moved on from the original Zeiss microscope to a Wild microscope with click-change magnification, and then to zoom magnification, using an Olympus zoom microscope. Like the Bausch and Lomb microscope, the Olympus was designed for laboratory bench work. It had a magnification range of 5.5x to 22x, but its free working distance was short at 12cms. Dekking had discovered a use for the mirror which was positioned so as to reflect the illumination. He fixed a telescopic system, with beam splitter, to the mirror aperture so that two observers could watch the operation at 9x magnification and up to two feet away (Fig.65 see p.56).

After using the Olympus zoom microscope, Dekking acquired the power-pod of the Keeler, Bausch and Lomb StereoZoom microscope which he considered the best zoom type microscope because of its free working distance and fine optics. However, he missed the occasional use of coaxial illumination provided by the Zeiss microscope, as is outlined in a personal communication in February 1965. (Fig. 66 see p.56)

“As you will be aware, the only advantage of the old Zeiss operating microscope over all later types is that it has a built-in light source which gives an almost co-axial illumination. This means that there is a bright red fundus reflex, which is extremely helpful in all operations on the lens: the smallest impediments are clearly perceived as black spots or veils against the red background, which cannot be seen at all with light coming from the side.

I therefore built a small projection unit with a prism that extends just to the border of the microscope’s objective lenses and which fits exactly on the B & L microscope. Though only a 15 watt built is used, the light at the full voltage of 6v is so strong that most patients cannot endure it, so we mostly run it on 4 to 5 volts. The diameter of the light field is exactly the same as the viewing field of the microscope at its smallest magnification.

I think that most surgeons which use your equipment would enjoy this addition very much once they are acquainted with it.”

(Figs.67 and 68 see p.58).

Dekking had now motorised the X-Y movement of the microscope column and introduced a second motor which slowly turned

the vertical column from which the microscope was supported on a long horizontal bar (Fig.70 see p.58). This small movement describing part of an arc gave a fine backwards and forwards movement to the microscope head.

The indefatigable Henri Dekking, who had probably experimented with more microscope systems than anybody in the early pioneering years of ophthalmic microsurgery, died in November 1966.

BACK TO ZEISS

The story of the ophthalmic surgical microscope is not just about magnification, working distance and forms of illumination, but of the various ways in which the microscope could be mounted. An alternative to the floor stands of Zeiss and the head-rest system of Keeler was the ceiling mount devised by the Barraquer family, firstly in Barcelona by Ignacio and Joaquin, and then in Bogota by José²⁸ (Figs.70, 71 and 72 see p.58).

The suspension of the microscope from the ceiling was achieved before 1962 by Joaquin Barraquer, employing a special column devised by his father, Ignacio, for use in cinematography and the holding of other equipment and instruments (Fig.73 see p.60). The control of lights and focussing of the microscope was done by foot operation of an electric motor mounted in the base of a special chair, complete with arm rests. In 1962, Barraquer added an X- Y mechanism to the operating table itself.

Another system for mounting the microscope was devised by Troutman. He placed a modified Barraquer chair on to the base of a shock-proof, motor driven hydraulic unit from Ritter which was on heavy-duty castors and could be blocked for stabilisation when in position. The Zeiss surgical microscope, complete on articulated arm but removed from its base, was attached to the back of the chair. The whole unit could then be moved up to the operating table.²⁶

The recording of operations either by still photography, movie or video was an important development in ophthalmic surgery pioneered by Zeiss. Their surgical microscopes, including the Diploscope, had a variety of attachments and adaptors to cover all methods of recording.

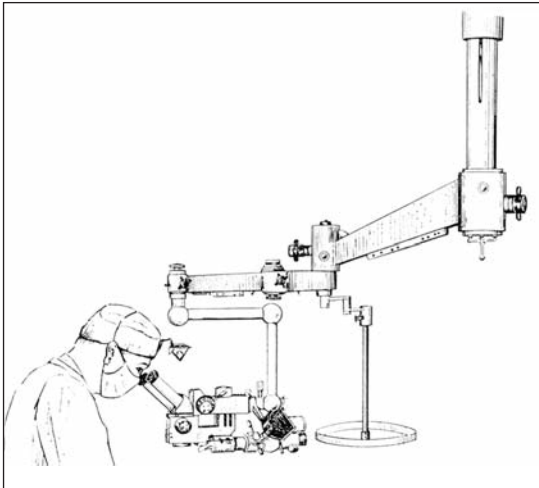

Fig.73: Barraquer ceiling mounted microscope

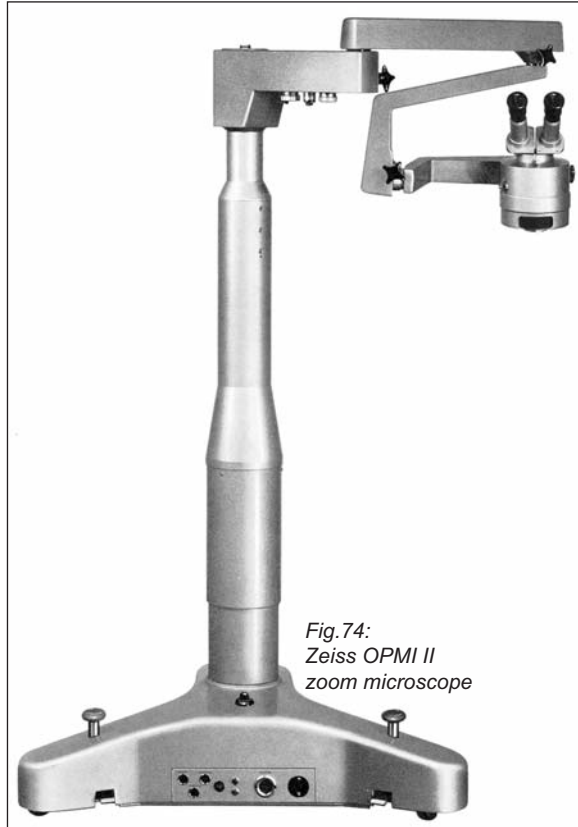

Fig.74:
Zeiss OPMI II
zoom microscope

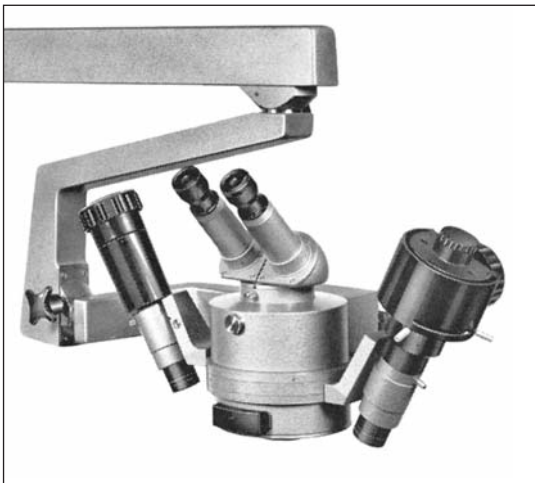

Fig.75:
Zeiss OPMI II
zoom microscope with lights

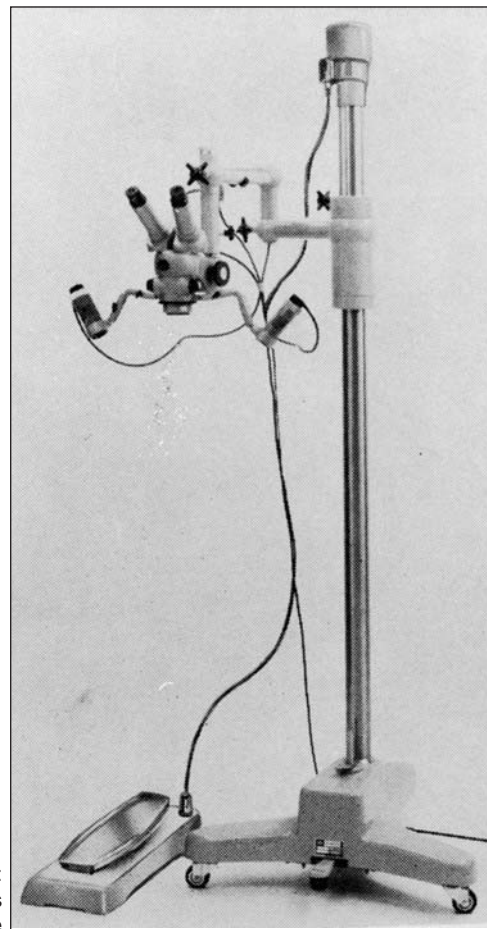

Fig.76:
Storz-Troutman-Zeiss
zoom microscope

Zeiss's first venture into zoom optics in a surgical microscope was in 1965. The microscope was known as the OPMI II²⁹ (Fig.74 *see p.60*). Mounted on a sturdy stand with completely internal wiring, the zoom microscope was built on a modular basis. Apart from its simplest mode of zoom microscope, with two focusable lamps, (Fig.75 *see p.60*) a beam splitter allowed, as an alternative, the use of an assistant's microscope, observer tube and photographic attachment all on the same instrument. The specially designed zoom system for microsurgery provided a continuous change of magnification at the ratio of 1:5. By using different objectives and eyepieces, already available on other Zeiss microscopes, the surgeon could choose a zoom range of, for example, 2.5 to 12.5x or up to 10.7 to 53.5x. The most usual choice was the range from 5 to 26x. Both focussing and zoom change operations were carried out by remote foot controlled motors.

Before Zeiss's zoom microscope OPMI II was commercially available, a hybrid zoom microscope had appeared in 1964, constructed by the Storz Instrument Company of St Louis with the assistance of Troutman (Fig.76 *see p.60*). The microscope used the new Zeiss zoom optics which had been developed for the line of laboratory bench microscopes and later their range of slit lamps. It featured a motorised focussing device and magnification changer, both foot-operated, leaving the surgeon's hands free for operating. This was the first zoom microscope to have both these features. The eyepieces were angled and convergent. Illumination was from two oblique lamps which could be placed in any position.³⁰

After the introduction of the Diploscope, the first Zeiss microscope specifically designed by Dr Littmann for ocular surgery was launched in 1966.³¹ This microscope became known as the Zeiss OPMI 3 (Fig.77 *see p.62*). It was the Barraquer brothers who established the requirements for this design following a question that José was asked at the Cornea World Congress in Washington in 1964 as to what he thought would be the ideal surgical microscope. In his reply he categorically stated that the microscope should allow the surgeon to operate from a comfortable sitting position and that the distance from the operator's eyes to those of the patient should

be as short as possible and no more than 30cm. The microscope should have a moveable lamp with homogeneous illumination and also a slit-lamp that could be rotated in the desired meridian. This lamp should have a diaphragm that could be opened to provide secondary homogeneous illumination.

The Zeiss OPMI 3 microscope was launched two years later in 1966, by which time a third arm for a lamp with homogeneous illumination had been added. The OPMI 3 was, in effect, a fixed magnification microscope during the operation. In the Barraquer clinics the microscope was suspended from the operating theatre ceiling and fine focussing was by motorised footswitch.

A busy year for Zeiss ended with the launch of a new double microscope to replace the Diploscope, which was considered to be too bulky and unwieldy. The Harms double microscope known as the Zeiss OPMI 5 was altogether different (Fig.79 *see p.62*). Two compact binocular microscopes could be rotated individually around a central column so that they could be positioned at any angle to each other. Each microscope had a Galilei manual 'click' magnification change system and the dual microscopes had illumination from two oblique lamps. The oculars for the surgeon had a broken angle, whereas the assistant had a choice of straight, or broken, angle oculars.

THE OTHER ZEISS

THE JENA OPERATING SLIT LAMP MICROSCOPE

While Zeiss, in Oberkochen, West Germany, were developing operating microscopes in the 1950s and 1960s, under their chief scientific designer, Dr Hans Littmann, the original Jena branch of Zeiss had been producing their own general operating microscopes. In 1963 an operating slit-lamp microscope for ophthalmic surgery was manufactured under the supervision of Professor Karl Velhagen of the University Eye Clinic in Berlin (Fig.80 *see p.62*).

It was designed to bring the advantages of slit illumination and the stereoscopic microscope to eye surgery on recumbent patients. The microscope and stand was of a sturdy construction (Fig.81 *see p.62*). The move-

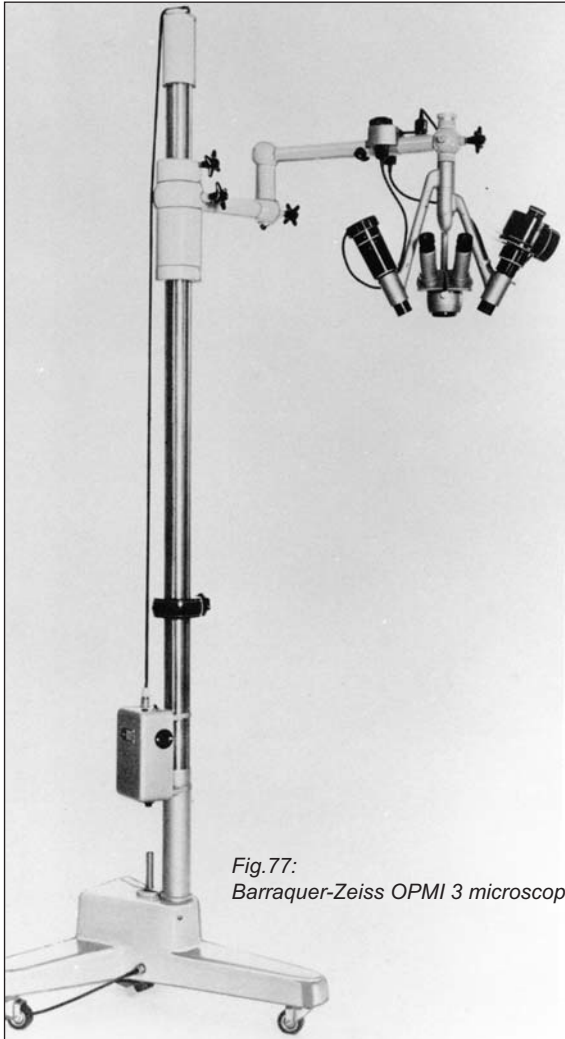

Fig.77:
Barraquer-Zeiss OPMI 3 microscope

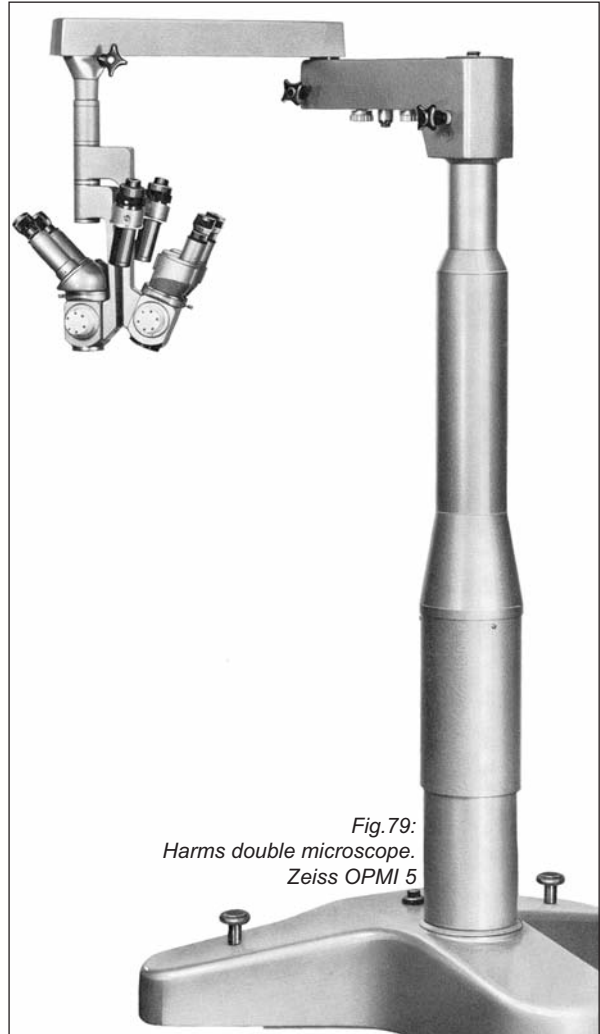

Fig.79:
Harms double microscope.
Zeiss OPMI 5

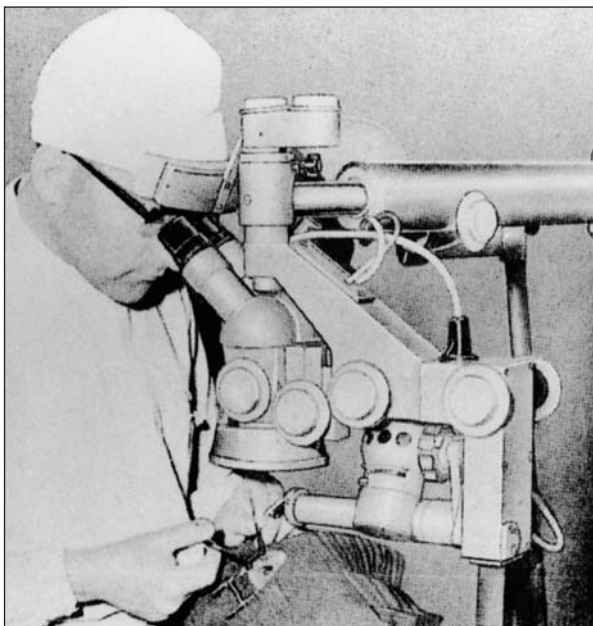

Fig.81: Velhagen's microscope by Carl Zeiss

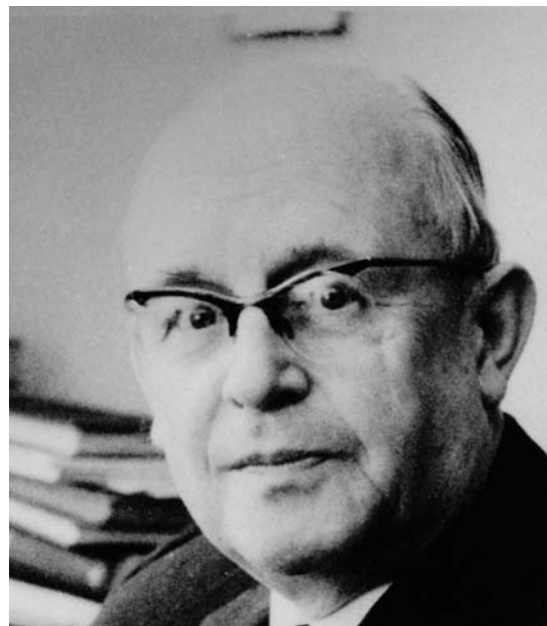

Fig.80: Karl Velhagen 1897-1990

able pedestal contained a foot-operated hydraulic pump for height adjustment. At the head of the pedestal an extendable arm was pivoted giving an arc of 60° through which it could be swung. At the end of this arm there were two shafts, the inner shaft holding a head rest, while the lower one carried the microscope and slit-lamp. The slit-lamp could be swung through $+45^\circ$ in the horizontal axis and $+330^\circ$ in the vertical. The microscope and head rest were independent of the slit-lamp and could be swung $+90^\circ$ round the vertical axis. The microscope had electrically controlled fine focussing. The microscope had a click-stop magnification choice of 4x, 6.3x, 10x, 16x and 25x. The slit lamp was of a standard manufacture and because of this the free working distance was very close.

MÖLLER-WEDEL

In 1966, at the 20th International Congress of Ophthalmology in Munich, a company new to ophthalmic surgical microscopes, J D Möller-Wedel of Germany introduced a complete microsurgical unit which was both highly complex and expensive (Fig.82). This was the brainchild of Professor Hans Sautter and Jorg Draeger of Hamburg^{32, 33}. Although the Barraquers, with their highly individualistic installation, had pioneered ceiling suspension of the microscope, illumination and recording facilities, the Möller unit was not only mounted from the ceiling, but was the first fully comprehensive microsurgical unit. In addition to the motorised zoom microscope giving a continuous magnification range of 3x to 15x at a free working distance of 16cms, there were two lamps, film, TV and microphone. The suspension also incorporated equipment such as cautery, diathermy, ophthalmoscope, anaesthetic outlets and erysophake. All of the equipment was connected to a single flexible cable. Control of the various instruments was by a series of footswitches mounted at the base of a special chair. The chair incorporated arm rests and could be adjusted in height and angle to suit the individual surgeon's requirements. The Sautter/Draeger system also had an operating table with an electrically operated X-Y mechanism operated by footswitch for centring the patient's eye in the operating field. Coaxial illumination and an assistant's microscope were later additions to the microscope.

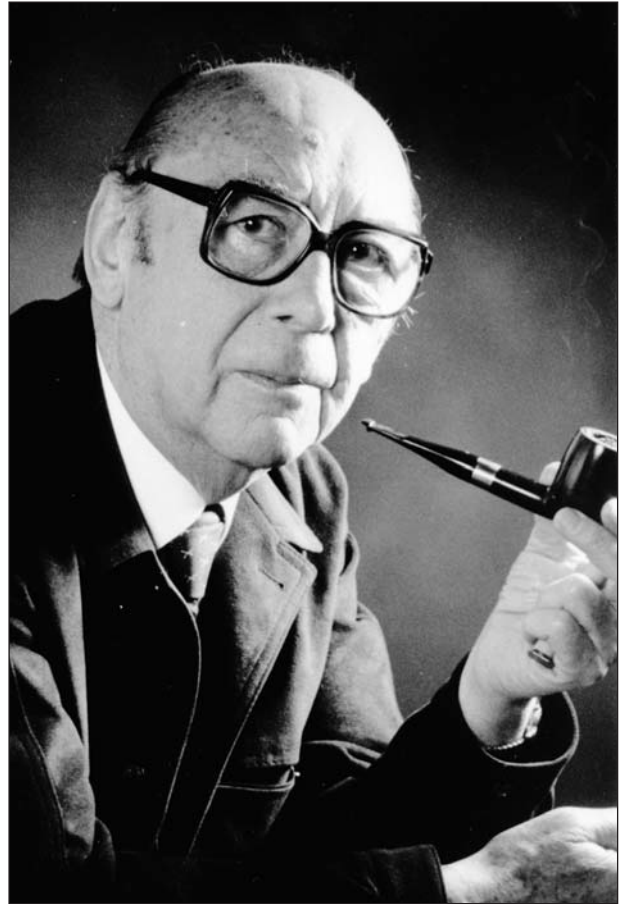

Fig.83: Helmut Dannheim (1907-1993)

DANNHEIM MICROSCOPE SYSTEM

The idea of orientating the patient on the operating table under the static microscope was reported by Dr Helmut Dannheim (Fig.83) some years before, in 1961.³⁴ Dannheim pointed out that perhaps the lack of enthusiasm for the operating microscope on the part of ophthalmologists was the frequent need to recentre the microscope and refocus the eye after every small movement by the patient.

To overcome these difficulties, and to be able to continue to operate with both hands free, Dannheim used his feet to control movement while operating in the sitting position. His operating table (Fig.84), constructed with the assistance of Zeiss and Klopfer of Stuttgart, consisted of a flat board covered with a layer of thick foam rubber which lay on ball bearings on top of the main table structure. Using a foot pedal with a transmission ratio of 1:15, he was able to

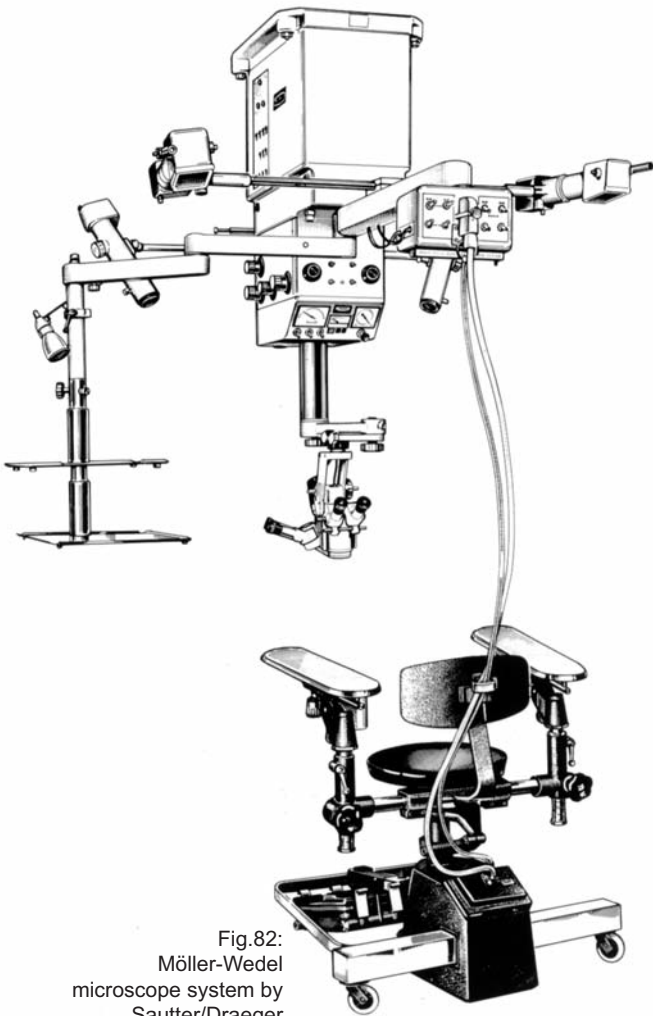

Fig.82:
Möller-Wedel
microscope system by
Sautter/Draeger



Fig.84:
Dannheim's floating operating table

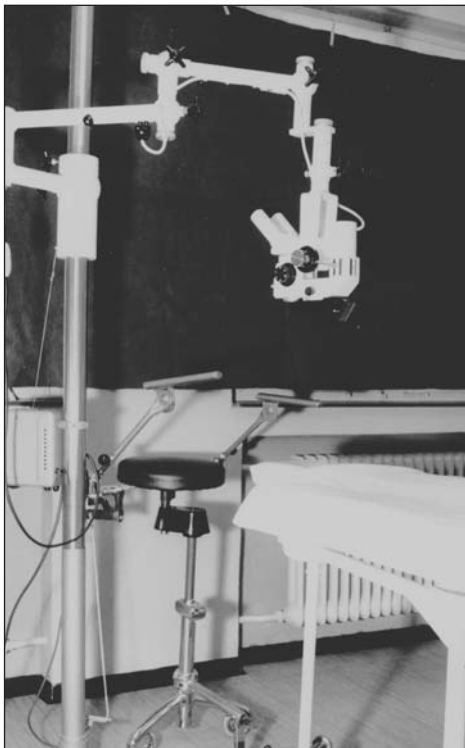

Fig.86:
Dannheim's ceiling/floor microscope column



Fig.87:
Marian Barraquer being presented to Princess Margaret
with Joaquin Barraquer (left) and Louis Paufigue looking on 1967

move the padded board in all directions regardless of the patient's weight. Very precise orientation of the eye and its surrounding tissue could be achieved quickly by foot control. On the foot pedal there were two switches connected to an electric motor to focus the microscope. One switch pulled the microscope down at the rate of 2.5mm per second and the other raised it at the same speed against a counterweight. The apparatus had a safety mechanism whereby the microscope would rise automatically if there was an electrical fault: in that event focussing would become manual. Dannheim found the large, heavy base of the Zeiss microscope disturbing. Instead of the moveable, base-mounted column, he attached the microscope with its articulated arm on a pole which stretched from floor to ceiling and was rigidly fixed in one position. The transformer and motor were clamped on to the lower part of the column.

Following Harms's example, he had constructed a roll-around chair, with adjustable armrests, connected to the footrest (Fig.86 see p.64). He was able to move in an arc of 180° around the patient without losing the advantage of adjusting the microscope with his footrest mechanism.

CONCLUSION

Even by the late 1960s, many ophthalmic surgeons were yet to be convinced about microsurgery. At the Corneo-Plastic Conference (Fig.87 see p.64) held in London in 1967, Ramon Castroviejo was asked why he didn't use a microscope. His answer echoed what many ophthalmic surgeons were still feeling: "*Use of the microscope is a matter of personal adaptation. It requires patience as time is lost manipulating the instrument. Many people prefer to use loupe glasses which are made as strong as 5x now with a strong illuminating source of light. I use a microscope in all cases of corneal grafting, not during the whole operation, mainly for inserting stitches. I find that if the microscope is small enough, I can work as fast using it as without one, and with much more ease.*"

In July 1963, Dr Gerard DeVoe wrote an editorial in the Archives of Ophthalmology³⁵ with the title "A forward look at oph-

thalmic surgery". He concluded that ophthalmic surgery had attained a high level of efficiency. He went on to state: "*It is probable that with present instrumentation little further improvement in technique is likely to occur. I would like to propose that the real future of ophthalmic surgery, from a technical standpoint at least, lies in the development of microsurgery*".

In 1966, the first meeting of the Microsurgery Study Group convened a symposium in Tübingen in Germany on the subject 'Microsurgery of the Eye'.³⁶

There were 38 participants from 14 countries, including four representatives from industry. Many issues were discussed at that meeting, covering the future of all aspects of microsurgery including microscopes, surgical instruments and sutures. These early pioneers of microsurgery had no doubt about the importance of producing the right design in surgical microscopes and instruments for the future of ocular surgery. Their commitment duly bore fruit, and few ophthalmic surgeons today work without the microscope for most procedures, enjoying surgical instruments and sutures which were only a dream in the 1950s.

REFERENCES

1. Landolt I E: Review of surgical loupes. *Handbuch der Augenheilkunde*. Berlin, Springer 1920, 354-360.
2. Jackson E: Magnifying lenses for use when operating. *Arch: Ophthal* 1897; 26: 274-277.
3. Rohr M v, Stock W: Ueber eine achromatische Brillenlupe Schwacher Vergrößerung. *Klin. Mbl. Augenheil*:1913; 51, 206-210.
4. Liebreich R: Seitliche Beleuchtung und mikroskopische Untersuchung am lebenden Auge. *Arch. f. Ophthalmologie* 1854;1.1, a 1, 351-356.
5. Wecker L de: *Études Ophtalmologiques* 1863; Vol I, 272.
6. Laqueur L: *System of Diseases of the Eye* Vol II, ed. Norris W F, Oliver C A. J B Lippincott Co 1897; 58.
7. Zehender K W v: Beschreibung der binocularen Cornea-Loupe. *Klin. Mbl. Augenheil*. 1887; 25: 496-499.
8. Laqueur L: *System of Diseases of the*

- Eye* Vol II, ed. Norris W F, Oliver C A. J B Lippincott Co 1897; 57.
9. Axenfeld T: Eine neue Westien'sche binoculare Handloupe (Brillenloupe). *Klin. Mbl. Augenheil.* 1900; 38: 20-25.
 10. Buchanan L: A new portable corneal microscope. *The Ophthalmoscope.* 1908; 957.
 11. Czapski S: Binokulares Corneal Mikroskop. *v Graefe Arch f. Ophthal.* 1899; Band XLVIII S: 229-235.
 12. Mawas J: La Biomicroscopie de l'oeil. *Bull. et mém. Soc. Franc. d'opht* 1925; 38,527.
 13. Nylén C O: The microscope in aural surgery, its first use and later development. *Acta Oto-laryng* (Stockh) Suppl 116 1954; 226-240.
 14. Perritt R A: Micro Ophthalmic Surgery. *Belgica Acta* Vol II 1958: 1680-1683. Perritt R A :The Operating Microscope in practice. *Adv. Ophthamol* 1968 ; 20, 21
 15. Littmann H: Das Operationsmikroskop. *Zeiss- Information* 1953 ; Heft 10 Littmann H: Ein neues Operations - Mikroskop. *Klin. Mbl. Augenheil.* 1954; 124: 473- 476.
 16. Harms H: Augenoperationen unter dem binocularen Mikroskop. *Ber. Dtsch. Ophth. Gesellsch* Heidelberg 1953; 58: 119-122.
 17. Harms H. Mackensen G: *Augenoperationen unter dem Mikroskop.* Tübingen. Verlag. Stuttgart 1966. *Ocular Surgery under the microscope.* Year Book Medical Publishers Chicago, 1967.
 18. Dekking H M: Use of the binocular microscope in eye operations. *Arch. Ophthal* 1956; 55, 114-117.
 19. Ruben C M: Operation-table head pillow. *Brit. J. Ophthal* 1959; 43: 117.
 20. Barraquer J : La extracción intracapsular del cristalino. Barcelona, *Soc. Oft . Hispano- Mericana* 196.. 58-59 Barraquer J: Comments on Microsurgery. *Adv. Ophthal.* Karger 1968; 20, 7-15.
 21. Becker B: The Zeiss Operating Microscope. *Amer. J. Ophthal* 1956; 42, 302-3,
 22. Barraquer J 1: The Microscope in Ocular Surgery. *Amer. J. Ophthal.* 1956; 42, 916-918.
 23. Pitts Crick R. Discussion. *Trans. Op. Soc. UK* 1967; 87, 237.
 24. Hopkins H H: *Biog Mem. Fell. R. Soc. Lond.* 1998: 44, 233-252.
 25. Troutman R C: The Operating Microscope in Ophthalmic Surgery. *Tr.Am. Ophth. Soc.* 1965; 63, 335-348
 26. Troutman R C: High Magnification in Surgery of Cataract. Symposium on Cataracts. *Trans. New Orl Acad. Ophth.* C V Mosby: 1965; 115-136
 27. Keeler C R: The Keeler Micro Ophthalmic Surgical Unit. *Adv. Ophth.* Karger 1968; 20, 51-61.
 28. Barraquer J I: The History of the Microscope in Ocular Surgery. *J Microsurgery.* Jan/Feb 1980: 288-299.
 29. Littmann H : The Microscopes of Zeiss. *Adv. Ophthalm:* Karger 1968: 20, 65.
 30. Troutman R C. The Operating Microscope in Corneal Surgery. *The Cornea World Congress.* Butterworths. Washington 1965; 428.
 31. Barraquer J I, Barraquer J, Littmann H: A New Operating Microscope for Ocular Surgery. *Amer. J. Ophthal* 1967: 63, 90-97. Barraquer J I, Barraquer J, Littmann H : *Ein besonders geeignetes operationsmikroskop fur die Augen Chirurgie.*
 32. Sautter H, Draeger J: Technical Improvements in Ophthalmic Microsurgery. *Adv. Ophthalm:* Karger 1968; 20, 66-79.
 33. Draeger J: Discussion. *Trans Ophth. Soc UK:* 1967; 87, 230-234.
 34. Dannheim H: Ein Beitrag zur Mikrochirurgie. *Klin Mbl Augenheil* 1961;138, 874-876.
 35. DeVoe A G: A forward look at Ophthalmic Surgery. *Arch. Ophthal* 1963; 70, 2-4.
 36. Mackensen G, Roper-Hall M, Troutman R C (Eds): *Microsurgery of the Eye.* *Adv. Ophthalm* Karger 1968; 20.